

Air Conditioning
Technical Data

FBA-A

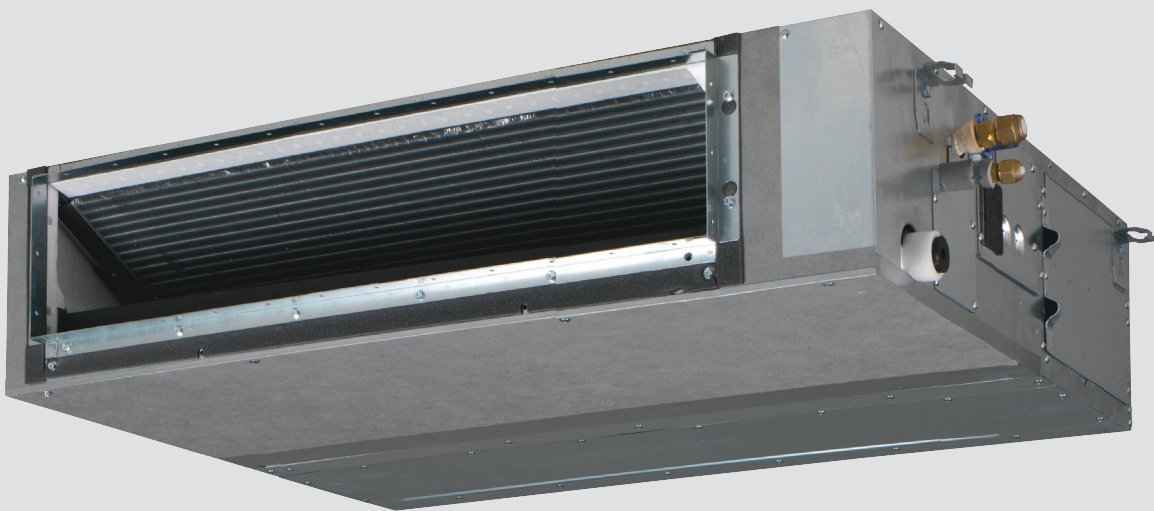

- > FBA35A2VEB
- > FBA50A2VEB
- > FBA60A2VEB
- > FBA71A2VEB
- > FBA100A2VEB
- > FBA125A2VEB

- > FBA140A2VEB

TABLE OF CONTENTS

FBA-A

1	Features	2
2	Specifications	3
	Technical Specifications	3
	Electrical Specifications	4
3	Options	5
4	Dimensional drawings	6
5	Centre of gravity	9
6	Piping diagrams	10
7	Wiring diagrams	11
	Wiring Diagrams - Single Phase	11
8	Sound data	12
	Sound Pressure Spectrum	12
9	Fan characteristics	16
10	Installation	18
	Installation Method	18

1 Features

Slimmest yet most powerful medium static pressure unit on the market

- Slimmest unit in class, only 245mm (300mm built-in height) and therefore narrow ceiling voids are no longer a challenge
- Low operation sound level down to 25dBA
- Medium external static pressure up to 150Pa facilitates using flexible ducts of varying lengths
- Unified indoor unit can be combined with R-32 and R-410A outdoor units, simplifying stock
- Combining with R-32 Bluevolution technology, reduces environmental impact with 68% compared to R-410A, leads directly to lower energy consumption thanks to its high energy efficiency and has up to lower 16% refrigerant charge
- Possibility to change ESP via wired remote control allows optimisation of the supply air volume
- Discretely concealed in the ceiling: only the suction and discharge grilles are visible
- Multi zoning kit allows multiple individually-controlled climate zones to be served by one indoor unit
- Reduced energy consumption thanks to specially developed DC fan motor
- Optional fresh air intake
- Flexible installation: air suction direction can be altered from rear to bottom suction and choice between free use or connection to optional suction grilles
- Standard built-in drain pump with 625mm lift increases flexibility and installation speed

1

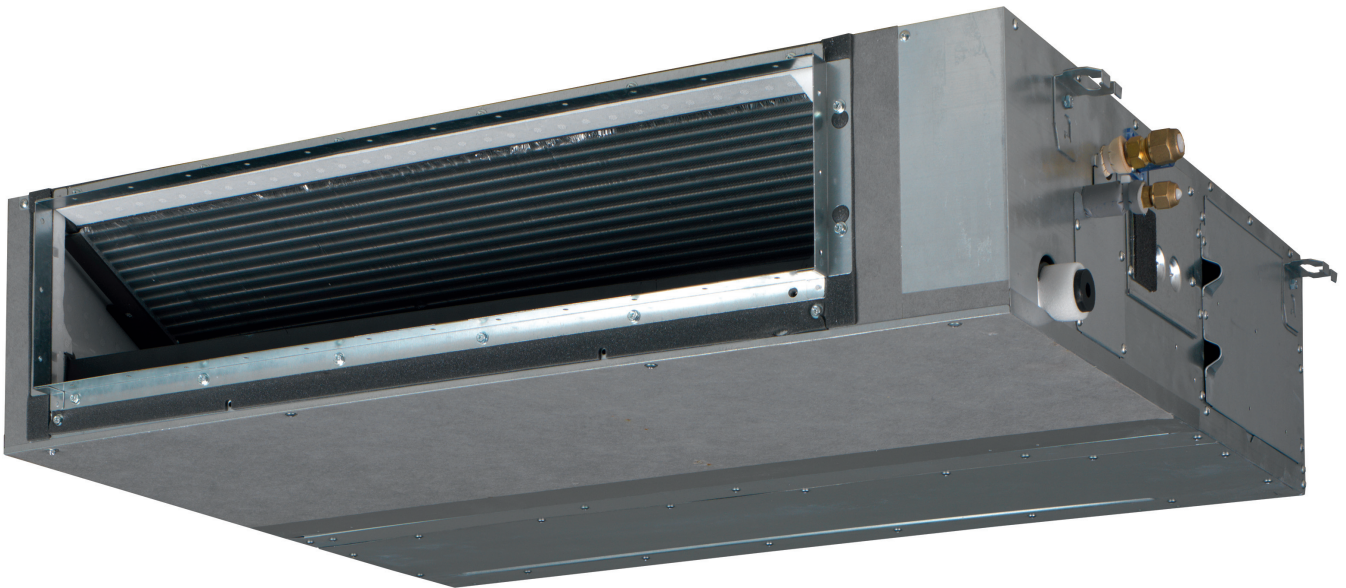

- | | | | | | | | | |
|-------------------------|--------------|-------------------------|----------------------|---------------------|---------------------------------|----------------|-----------------|-------------------------------------|
| | | | | | | | | |
| Infrastructure cooling | Multi zoning | Inverter | Home leave operation | Fan only | Auto cooling-heating changeover | Whisper quiet | Fan speed steps | Dry programme |
| | | | | | | | | |
| Air filter | Weekly timer | Infrared remote control | Wired remote control | Centralised control | Auto-restart | Self diagnosis | Drain pump kit | Twin/triple/double twin application |
| | | | | | | | | |
| Multi model application | | | | | | | | |

2 Specifications

2-1 Technical Specifications				FBA35A	FBA50A	FBA60A	FBA71A	FBA100A	FBA125A	FBA140A
Power input - 50Hz	Cooling	Nom.	kW	-					0.23	
	Heating	Nom.	kW	-					0.23	
Casing	Colour	Not painted (galvanised)								
	Material	Galvanised steel plate								
Dimensions	Unit	Height/Width/Depth	mm	245/700/800	245/1,000/800		245/1,400/800			
	Packed unit	Height/Width/Depth	mm	890/900/295	890/1,200/295		890/1,600/295			
Weight	Unit	kg		28.0	35.0		46.0			
	Packed unit	kg		30.5	38.0		49.0			
Heat exchanger	Fin	Type	Cross fin coil (Multi slit fins with hydrophilic treatment and Ø5Hi-XA tubes)							
Air filter	Type	Resin net								
Fan	Model	QD16A1CM/QD16A1DM								
	Type	Sirocco fan								
	Quantity				1	2		3		
	Air flow rate	Cooling	High	m³/min	15.0	18.0		29.0	34.0	
			Medium	m³/min	12.5 (1)	15.0 (1)		26.0 (1)	29.0 (1)	
			Low	m³/min	10.5	12.5		23.0	23.5	
		Heating	High	m³/min	15.0	18.0		29.0	34.0	
			Medium	m³/min	12.5 (1)	15.0 (1)		26.0 (1)	29.0 (1)	
			Low	m³/min	10.5	12.5		23.0	23.5	
	External static pressure	High	Pa	150						
Nom.		Pa	30		40		50			
Fan motor	Quantity	1								
	Model	Brushless DC motor								
	Speed	Steps	3							
	Output	Rated	W	130	230		300			
Sound power level	Cooling	dBA		60	56		58	62		
	Heating	dBA		-						
Sound pressure level	Cooling	High/Medium/Low	dBA	35.0/32.0 (1)/29.0	30.0/28.0 (1)/25.0		34.0/32.0 (1)/30.0	37.0/35.0 (1)/32.0		
	Heating	High/Medium/Low	dBA	37.0/34.0/29.0	31.0/28.0/25.0		36.0/33.0/30.0	38.0/35.0/32.0		
Control systems	Infrared remote control	BRC4C65 / BRC4C66								
	Wired remote control	BRC1D528 / BRC1E53A7 / BRC1E53B7 / BRC1E53C7								
Refrigerant	Type	R-32 / R-410A								
Piping connections	Sound absorbing insulation	Butyl Rubber								
	Liquid	Type/OD	mm	Flare connection/6,35			Flare connection/9,52			
	Gas	Type/OD	mm	Flare connection/9.52	Flare connection/12.70		Flare connection/15.90			
	Drain	VP20 (I.D. 20/O.D. 26)								
	Heat insulation	Foamed polystyrene / Foamed polyethylene								
Drain-up height	mm			625						

Standard Accessories : Operation manual; Quantity : 1;

Standard Accessories : Installation manual; Quantity : 1;

Standard Accessories : Drain hose; Quantity : 1;

Standard Accessories : Metal clamp for drain hose; Quantity : 1;

Standard Accessories : Washer for hanger bracket; Quantity : 8;

Standard Accessories : Screws; Quantity : 40;

Standard Accessories : Insulation for fitting; Quantity : 2;

Standard Accessories : Sealing pads; Quantity : 5;

Standard Accessories : Clamps; Quantity : 4;

2 Specifications

2-2 Electrical Specifications		FBA35A	FBA50A	FBA60A	FBA71A	FBA100A	FBA125A	FBA140A
Power supply	Phase	1~						
	Frequency	Hz	50/60					
	Voltage	V	220-240/220					

Notes

2

(1) See separate drawing for electrical data

The sound power level is an absolute value indicating the power which a sound source generates.

3 Options

3 - 1 Options

FBA-A

Discharge

Description	Option kit	SA		
		FBA3A FBA5A	FBA6A FBA7A	FBA10A FBA12A FBA16A
Air discharge adaptor for round ducts	KDAP25A56A	X		
	KDAP25A71A		X	
	KDAP25A140A			X

Operation control

Description	Option kit	SA		
		FBA3A FBA5A	FBA6A FBA7A	FBA10A FBA12A FBA16A
Wired remote control	BRC1E528	X	X	X
	BRC1E53A7	X(*7)	X(*7)	X(*7)
	BRC1E53B7	X(*8)	X(*8)	X(*8)
	BRC1E53C7	X(*9,10)	X(*9,10)	X(*9,10)
Central remote control	DCS302CA51	X	X	X
Unified ON/OFF controller	DCS301BA51	X	X	X
Intelligent touch controller	DCS601CS1	X	X	X
Schedule timer	DST301BA51	X	X	X
Adaptor for wiring (interlock for fresh air intake fan)	KRP1B54	X	X	X
Wiring adaptor for electrical appendices	KRP4A52	X(*4)	X(*4)	X(*4)
Wiring adaptor for electrical appendices	KRP4A51	X(*2,4)	X(*2,4)	X(*2,4)
Optional PCB for external electric heaters, humidifiers and/or hour meters	EKRP1B2A	X(*1,2)	X(*1,2)	X(*1,2)
Wireless remote control H/P	BRC4C65	X	X	X
Wireless remote control C/O	BRC4C66	X	X	X
Simplified remote control for hotel use	BRC2E52C7	X(*6,10)	X(*6,10)	X(*6,10)
Remote control for hotel use	BRC3E52C7	X(*6,10)	X(*6,10)	X(*6,10)
Remote sensor	KRC301-4B	X	X	X
Electrical box with earth terminal	KJB411A	X	X	X
Installation box for adaptor PCB	KRP1BA101	X	X	X
	KRP1B101	X	X	X
Digital input adaptor	BRP7A51	X(*3,5)	X(*3,5)	X(*3,5)
iTouch Manager	DCM601A51	X	X	X

- (*1) Electric heaters and humidifiers are field-supplied. Do not install them inside the equipment (refer to installation manual EKRP1B2A).
- (*2) When installing electric heaters, an optional PCB for external electric heaters (EKRP1B2) is required for each indoor unit. These options require mounting plate KRP4A96.
- (*3) Maximally 2 optional PCBs can be mounted.
- (*4) This option needs to be installed together with installation box KRP1B101/KRP1BA101.
- (*5) Only possible in combination with remote control BRC2/3E52C7, BRC1E53A/B/C7.
- (*6) Included languages are:
Language pack 1: English, German, French, Dutch, Spanish, Italian, and Portuguese.
With PC cable EKPCAB3 in combination with the Updater PC software, you can additionally change the language to:
Language pack 2: English, Bulgarian, Croatian, Czech, Hungarian, Romanian, and Slovenian.
Language pack 3: English, Greek, Polish, Russian, Serbian, Slovak, and Turkish.
- (*7) Included languages are: English, German, French, Italian, Spanish, Portuguese, and Dutch.
- (*8) Included languages are: English, Czech, Croatian, Hungarian, Slovenian, Romanian, and Bulgarian.
- (*9) Included languages are: English, Russian, Greek, Turkish, Polish, Albanian, and Slovak.
- (*10) Language pack 3 of controller BRCE1E53C7 is different from that of controller BRC2/3E52C7.

3D106133

4 Dimensional drawings

4 - 1 Dimensional Drawings

4

FBA35A

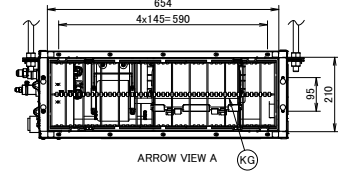
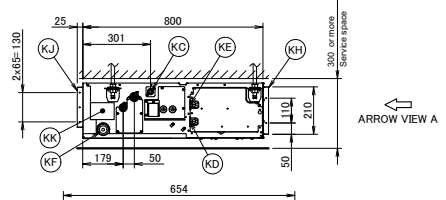
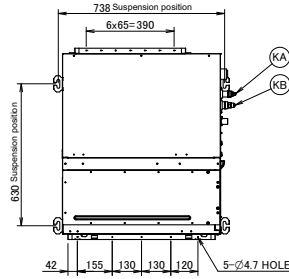
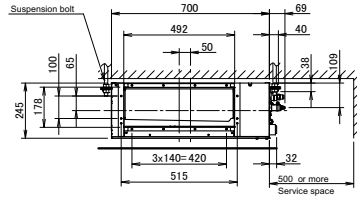
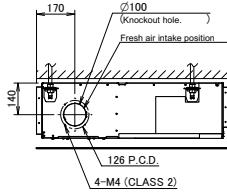

Item	Name	Description
KA	Liquid pipe connection port	Ø6.35 flared connection
KB	Gas pipe connection port	Ø9.52 flared connection
KC	Drain pipe connection	VP20 (OD Ø26, ID Ø20)
KD	Wiring connection	/
KE	Power supply connection	/
KF	Drain outlet	VP20 (OD Ø26, ID Ø20)
KG	Air filter	/
KH	Air suction side	/
KJ	Air discharge side	/
KK	Nameplate	/

Notes
 1. When installing optional accessories, refer to their respective documentation.
 2. The ceiling depth varies according to the documentation of the specific system.

3D094988B

FBA50A

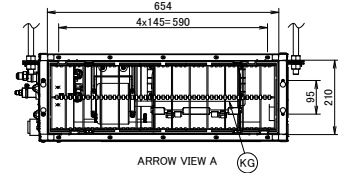
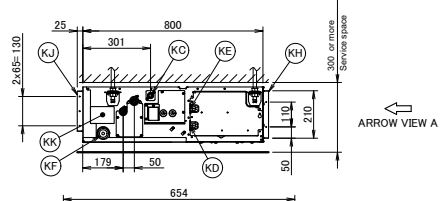
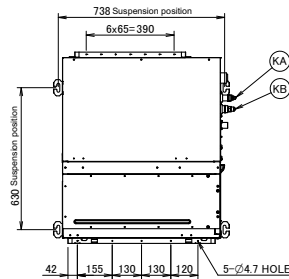
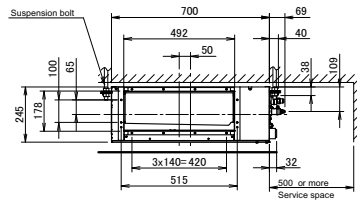
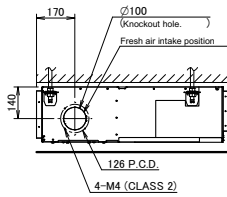

Item	Name	Description
KA	Liquid pipe connection port	Ø6.35 flared connection
KB	Gas pipe connection port	Ø12.70 flared connection
KC	Drain pipe connection	VP20 (OD Ø26, ID Ø20)
KD	Wiring connection	/
KE	Power supply connection	/
KF	Drain outlet	VP20 (OD Ø26, ID Ø20)
KG	Air filter	/
KH	Air suction side	/
KJ	Air discharge side	/
KK	Nameplate	/

Notes
 1. When installing optional accessories, refer to their respective documentation.
 2. The ceiling depth varies according to the documentation of the specific system.

3D094918B

6

4 Dimensional drawings

4 - 1 Dimensional Drawings

FBA60A

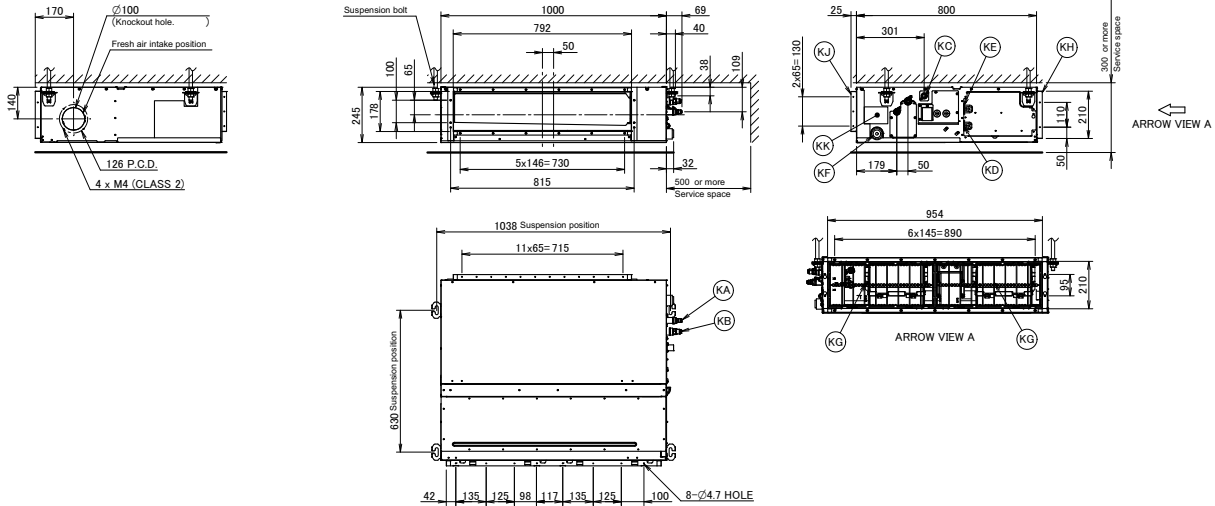

Item	Name	Description
KA	Liquid pipe connection port	Ø6.35 flared connection
KB	Gas pipe connection port	Ø12.70 flared connection
KC	Drain pipe connection	VP20 (OD Ø26, ID Ø20)
KD	Wiring connection	/
KE	Power supply connection	/
KF	Drain outlet	VP20 (OD Ø26, ID Ø20)
KG	Air filter	/
KH	Air suction side	/
KJ	Air discharge side	/
KK	Nameplate	/

Notes
 1. When installing optional accessories, refer to their respective documentation.
 2. The ceiling depth varies according to the documentation of the specific system.

3D094983B

FBA71A

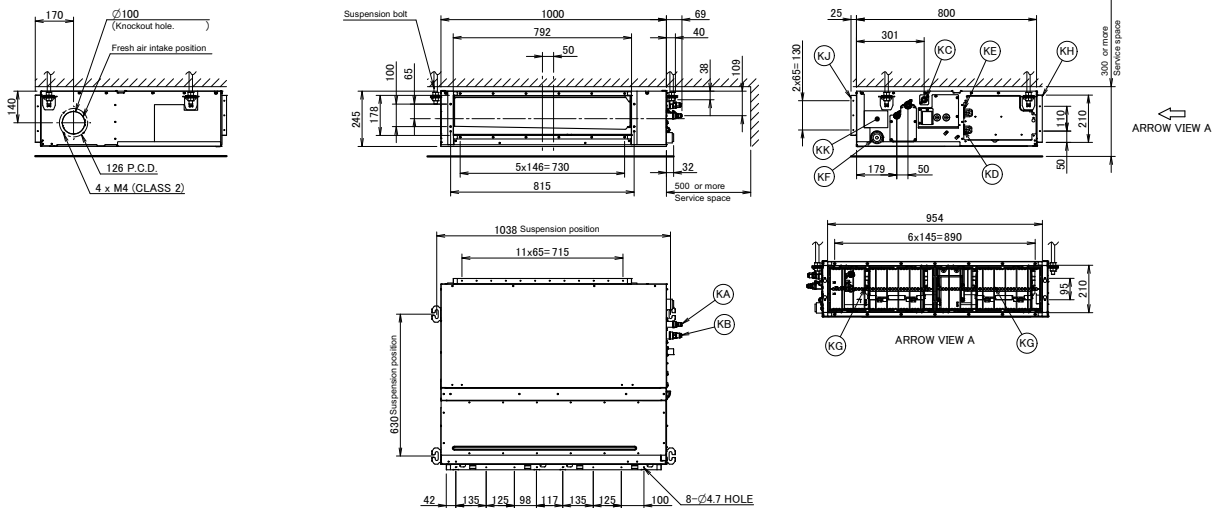

Item	Name	Description
KA	Liquid pipe connection port	Ø9.52 flared connection
KB	Gas pipe connection port	Ø15.90 flared connection
KC	Drain pipe connection	VP20 (OD Ø26, ID Ø20)
KD	Wiring connection	/
KE	Power supply connection	/
KF	Drain outlet	VP20 (OD Ø26, ID Ø20)
KG	Air filter	/
KH	Air suction side	/
KJ	Air discharge side	/
KK	Nameplate	/

Notes
 1. When installing optional accessories, refer to their respective documentation.
 2. The ceiling depth varies according to the documentation of the specific system.

3D094915B

4 Dimensional drawings

4 - 1 Dimensional Drawings

FBA100-140A

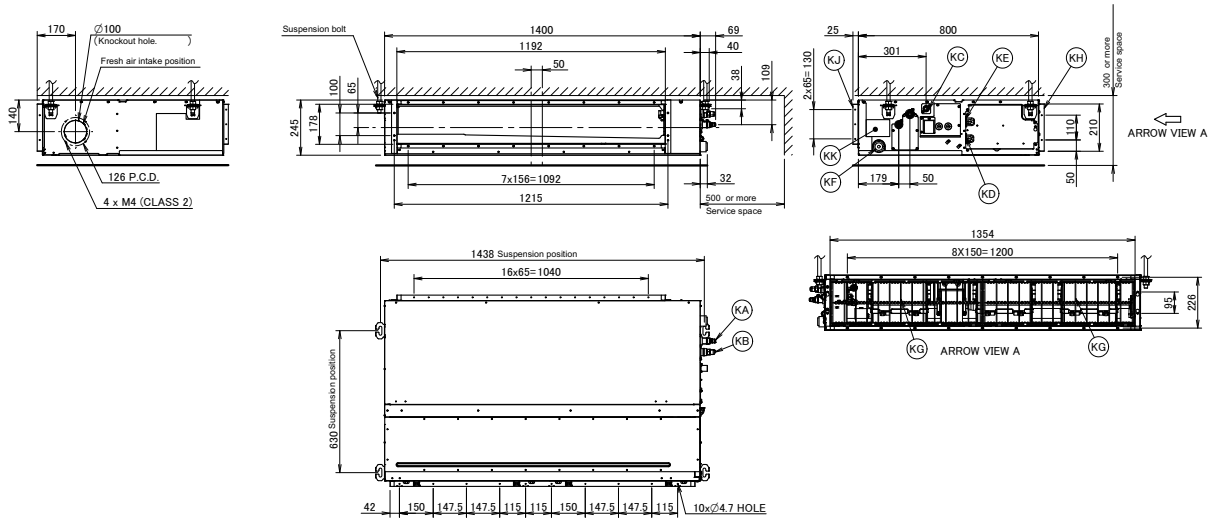

Item	Name	Description
KA	Liquid pipe connection port	Ø9.52 flared connection
KB	Gas pipe connection port	Ø15.90 flared connection
KC	Drain pipe connection	VP20 (OD Ø26, ID Ø20)
KD	Wiring connection	/
KE	Power supply connection	/
KF	Drain outlet	VP20 (OD Ø26, ID Ø20)
KG	Air filter	/
KH	Air suction side	/
KJ	Air discharge side	/
KK	Nameplate	/

- Notes
- When installing optional accessories, refer to their respective documentation.
 - The ceiling depth varies according to the documentation of the specific system.

3D094914B

5 Centre of gravity

5 - 1 Centre of Gravity

FBA-A

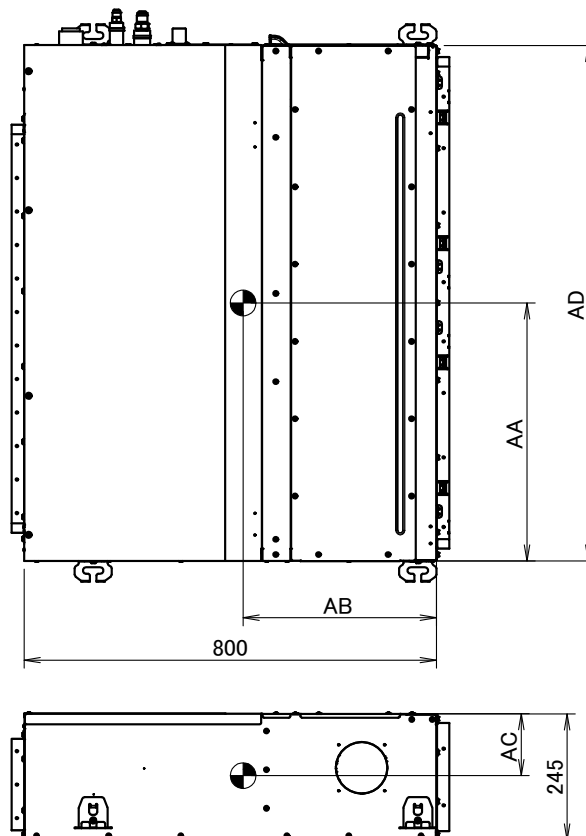

Applicable models	AA	AB	AC	AD
FBQ35/50	410	375	125	700
FBQ60/71	525	380	125	1000
FBQ100/125/140	760	390	115	1400
ADEQ71B2VEB	525	380	125	1000
ADEQ100/125B2VEB	760	390	115	1400
FBA35/50	410	375	125	700
FBA60/71	525	380 </td <td>125</td> <td>1000</td>	125	1000
FBA100/125/140	760	390	115	1400

4D093590B

6 Piping diagrams

6 - 1 Piping Diagrams

6

FBA-A

Piping connections Ø

Model	Gas	Liquid
FBQ35D2VEB	Ø 9.52	Ø 6.35
FBQ50D2VEB	Ø 12.70	Ø 6.35
FBQ60D2VEB	Ø 12.70	Ø 6.35
FBQ71D2VEB	Ø 15.90	Ø 9.52
FBQ100D2VEB	Ø 15.90	Ø 9.52
FBQ125D2VEB	Ø 15.90	Ø 9.52
FBQ140D2VEB	Ø 15.90	Ø 9.52
ADEQ71B2VEB	Ø 15.90	Ø 9.52
ADEQ100B2VEB	Ø 15.90	Ø 9.52
ADEQ125B2VEB	Ø 15.90	Ø 9.52
FBA35A2VEB	Ø 9.52	Ø 6.35
FBA50A2VEB	Ø 12.70	Ø 6.35
FBA60A2VEB	Ø 12.70	Ø 6.35
FBA71A2VEB	Ø 15.90	Ø 9.52
FBA100A2VEB	Ø 15.90	Ø 9.52
FBA125A2VEB	Ø 15.90	Ø 9.52
FBA140A2VEB	Ø 15.90	Ø 9.52

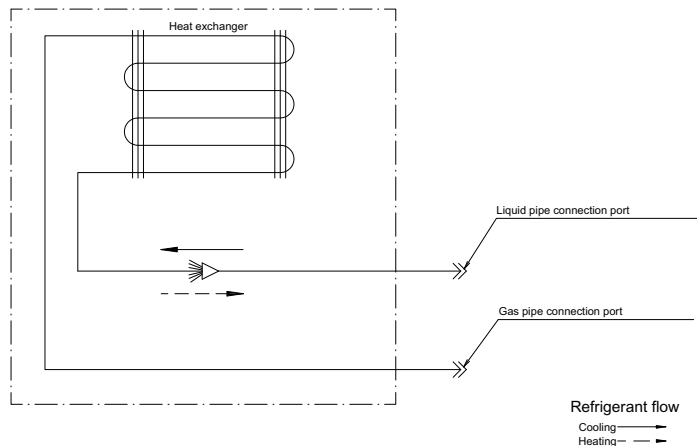

3D090271B

7 Wiring diagrams

7 - 1 Wiring Diagrams - Single Phase

FBA-A

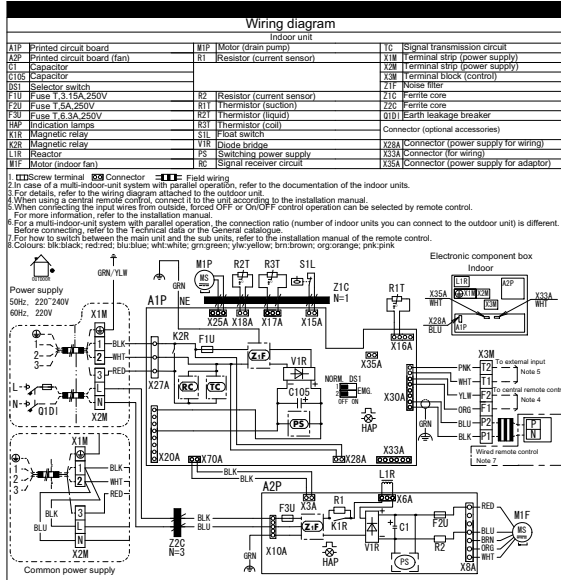

3D090350C

8 Sound data

8 - 1 Sound Pressure Spectrum

8

FBA35A

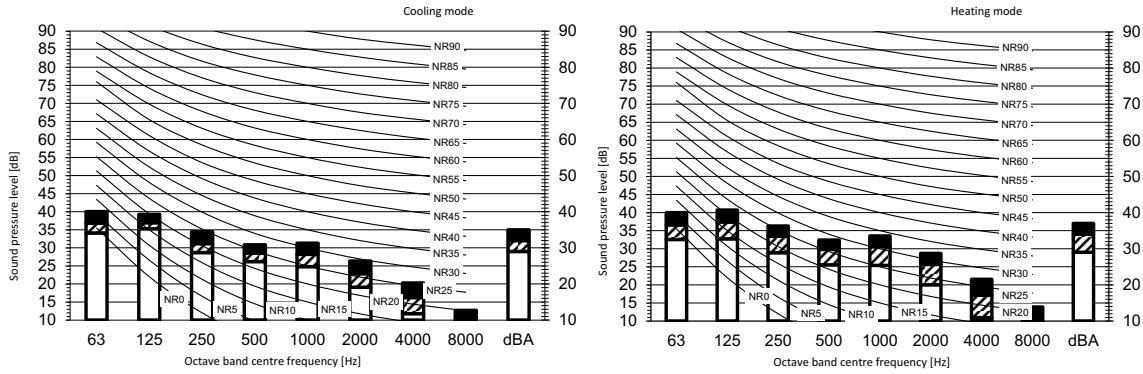

Legend
dBA = A-weighted sound pressure level (A scale according to IEC).

A Scale Fan speed
B High
C Medium
D Low
Location of microphone

Cooling		Total dB	
A	B	C	D
dBA	35	32	29

Heating		Total dB	
A	B	C	D
dBA	37	34	29

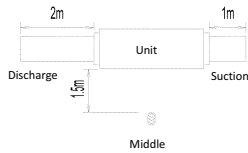

- Notes
- Operating conditions: power source 220-240 V/220 V 50/60 Hz; JIS standard
 - Background noise already taken into account.
 - Operating noise varies depending on operation and ambient conditions.
 - The operation noise measuring method is in accordance with JISC9612.
 - Measuring location: anechoic chamber

3D110166

FBA50A

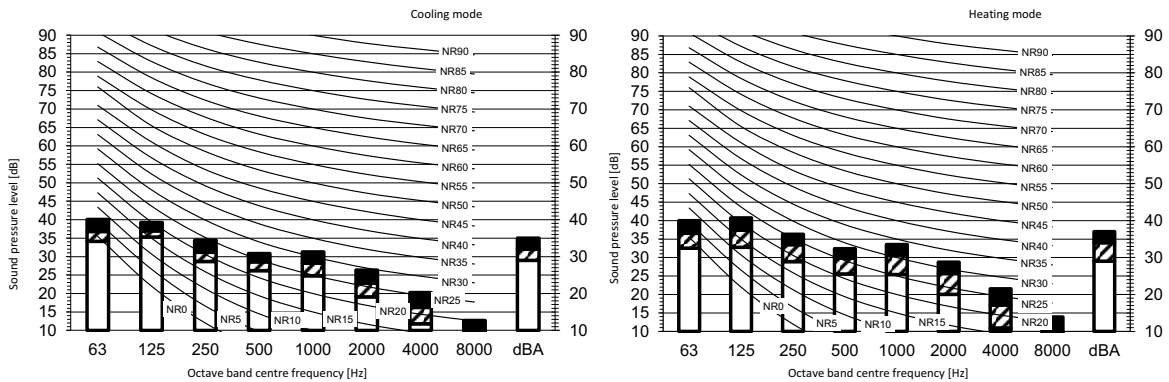

Legend
dBA = A-weighted sound pressure level (A scale according to IEC).

A Scale Fan speed
B High
C Medium
D Low
Location of microphone

Cooling		Total dB	
A	B	C	D
dBA	35	32	29

Heating		Total dB	
A	B	C	D
dBA	37	34	29

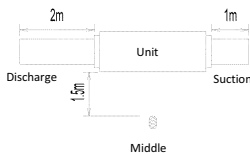

- Notes
- Operating conditions: power source 220-240 V/220 V 50/60 Hz; JIS standard
 - Background noise already taken into account.
 - Operating noise varies depending on operation and ambient conditions.
 - The operation noise measuring method is in accordance with JISC9612.
 - Measuring location: anechoic chamber

3D110167

8 Sound data

8 - 1 Sound Pressure Spectrum

FBA60A

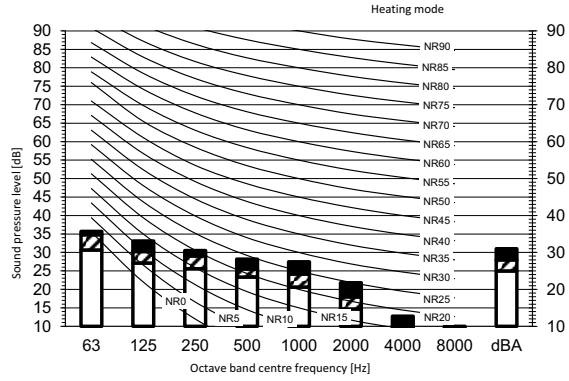
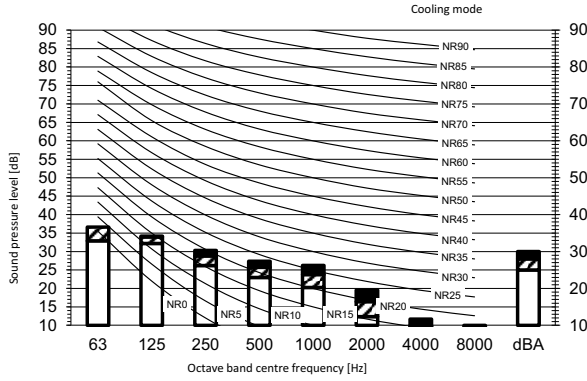

Legend
dBA = A-weighted sound pressure level (A scale according to IEC).

A Scale Fan speed

B High
C Medium
D Low

Location of microphone

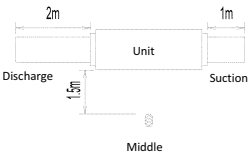

Cooling Total dB			
A	B	C	D
dBA	30	28	25

Heating Total dB			
A	B	C	D
dBA	31	28	25

- Notes
- Operating conditions: power source 220-240 V/220 V 50/60 Hz; JIS standard
 - Background noise already taken into account.
 - Operating noise varies depending on operation and ambient conditions.
 - The operation noise measuring method is in accordance with JISC9612.
 - Measuring location: anechoic chamber

3D110168

FBA71A

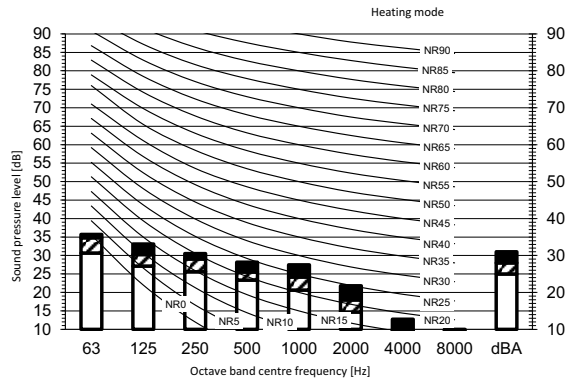
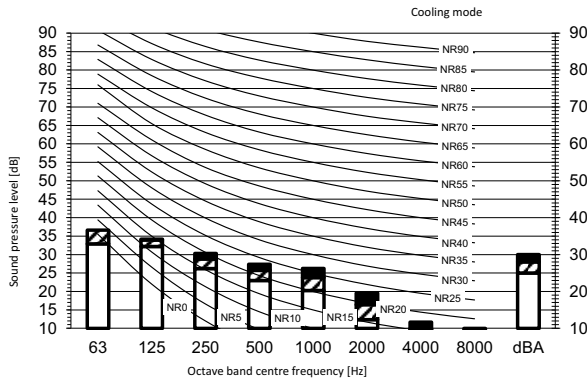

Legend
dBA = A-weighted sound pressure level (A scale according to IEC).

A Scale Fan speed

B High
C Medium
D Low

Location of microphone

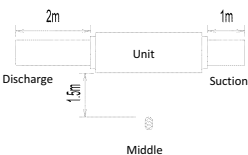

Cooling Total dB			
A	B	C	D
dBA	30	28	25

Heating Total dB			
A	B	C	D
dBA	31	28	25

- Notes
- Operating conditions: power source 220-240 V/220 V 50/60 Hz; JIS standard
 - Background noise already taken into account.
 - Operating noise varies depending on operation and ambient conditions.
 - The operation noise measuring method is in accordance with JISC9612.
 - Measuring location: anechoic chamber

3D110169

8 Sound data

8 - 1 Sound Pressure Spectrum

8

FBA100A

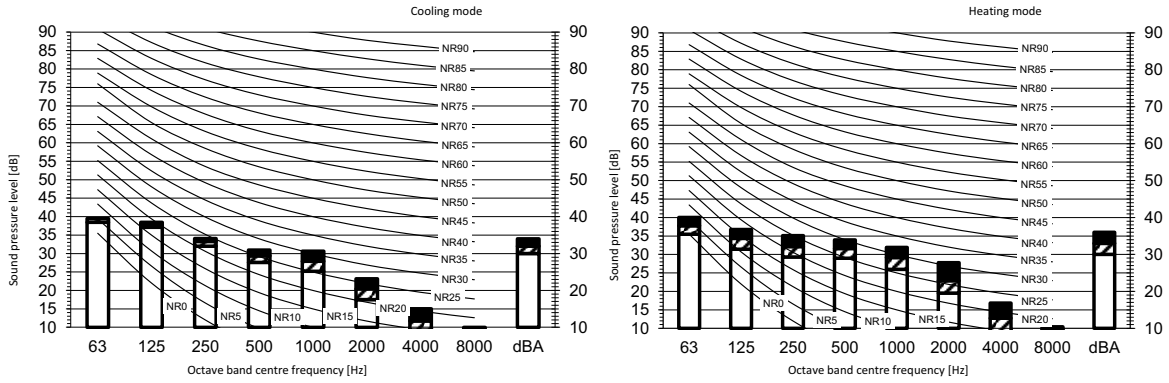

Legend
dBA = A-weighted sound pressure level (A scale according to IEC).

A Scale Fan speed

B High
C Medium
D Low

Location of microphone

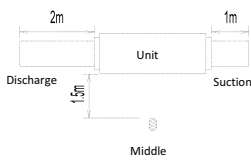

Cooling		Total dB	
A	B	C	D
dBA	34	32	30

Heating		Total dB	
A	B	C	D
dBA	36	33	30

Notes

- Operating conditions: power source 220-240 V/220 V 50/60 Hz; JIS standard
- Background noise already taken into account.
- Operating noise varies depending on operation and ambient conditions.
- The operation noise measuring method is in accordance with JISC9612.
- Measuring location: anechoic chamber

3D110170

FBA125A

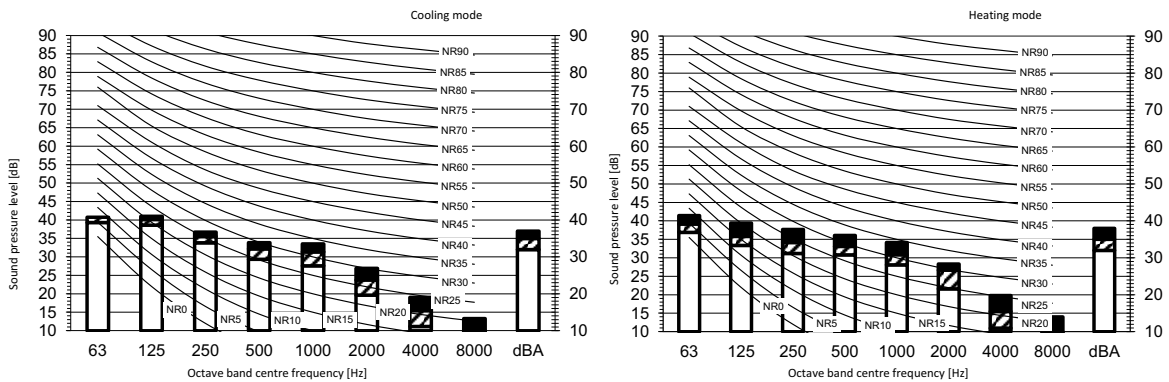

Legend
dBA = A-weighted sound pressure level (A scale according to IEC).

A Scale Fan speed

B High
C Medium
D Low

Location of microphone

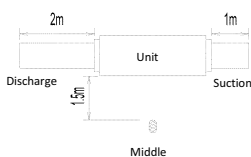

Cooling		Total dB	
A	B	C	D
dBA	37	35	32

Heating		Total dB	
A	B	C	D
dBA	38	35	32

Notes

- Operating conditions: power source 220-240 V/220 V 50/60 Hz; JIS standard
- Background noise already taken into account.
- Operating noise varies depending on operation and ambient conditions.
- The operation noise measuring method is in accordance with JISC9612.
- Measuring location: anechoic chamber

3D110171

8 Sound data

8 - 1 Sound Pressure Spectrum

FBA140A

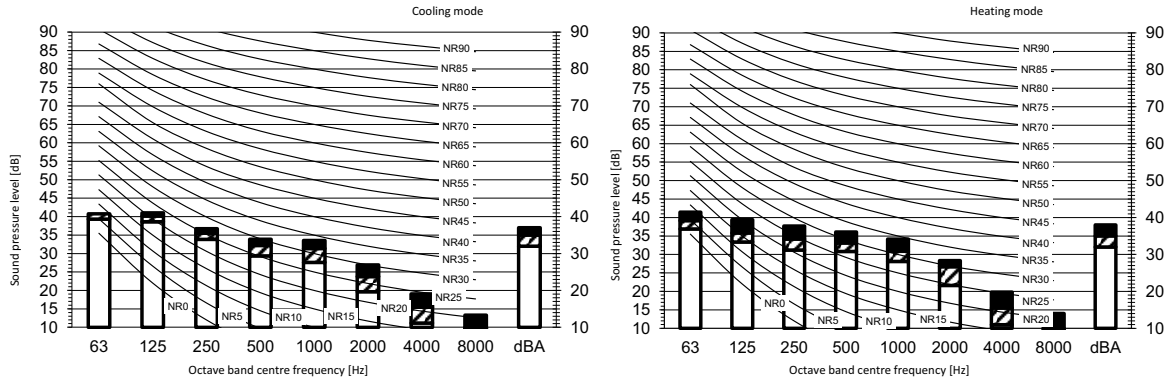

Legend

dBA = A-weighted sound pressure level (A scale according to IEC).

A Scale Fan speed

- B High
- C Medium
- D Low

Location of microphone

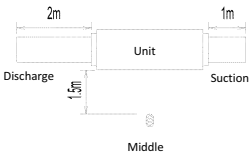

Cooling		Total dB	
A	B	C	D
dBA	37	35	32

Heating		Total dB	
A	B	C	D
dBA	38	35	32

Notes

1. Operating conditions: power source 220-240 V/220 V 50/60 Hz; JIS standard
2. Background noise already taken into account.
3. Operating noise varies depending on operation and ambient conditions.
4. The operation noise measuring method is in accordance with JISC9612.
5. Measuring location: anechoic chamber

3D110172

9 Fan characteristics

9 - 1 Fan Characteristics

9

FBA35-50A

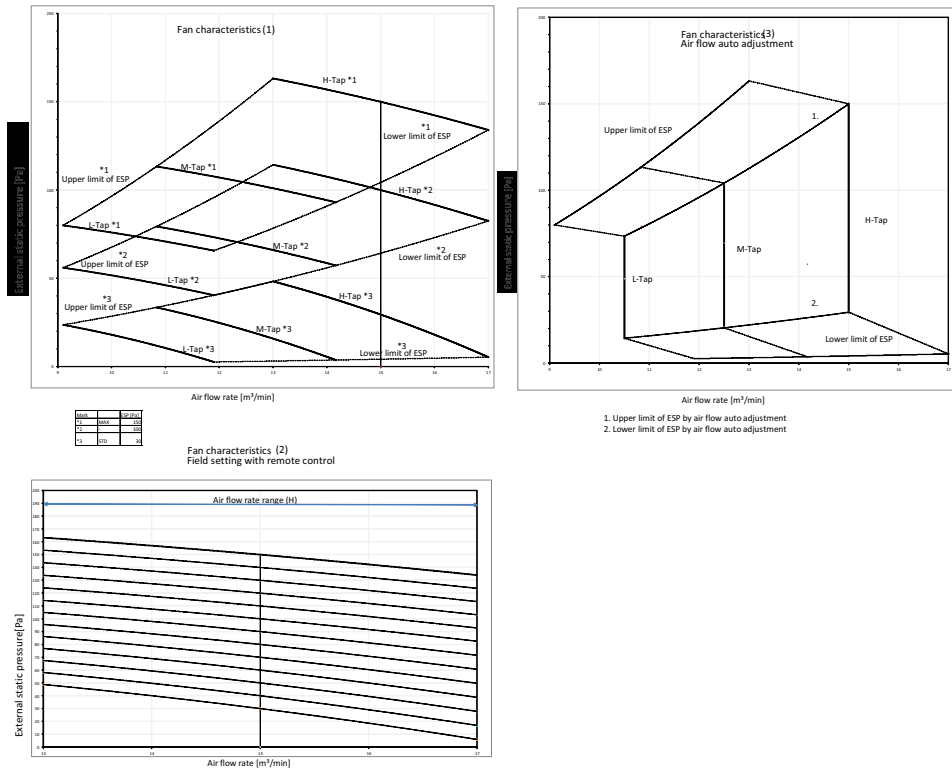

Notes:
1. The fan characteristics shown are in "fan only" mode.
2. ESP: External static pressure.

3D095521B

FBA60-71A

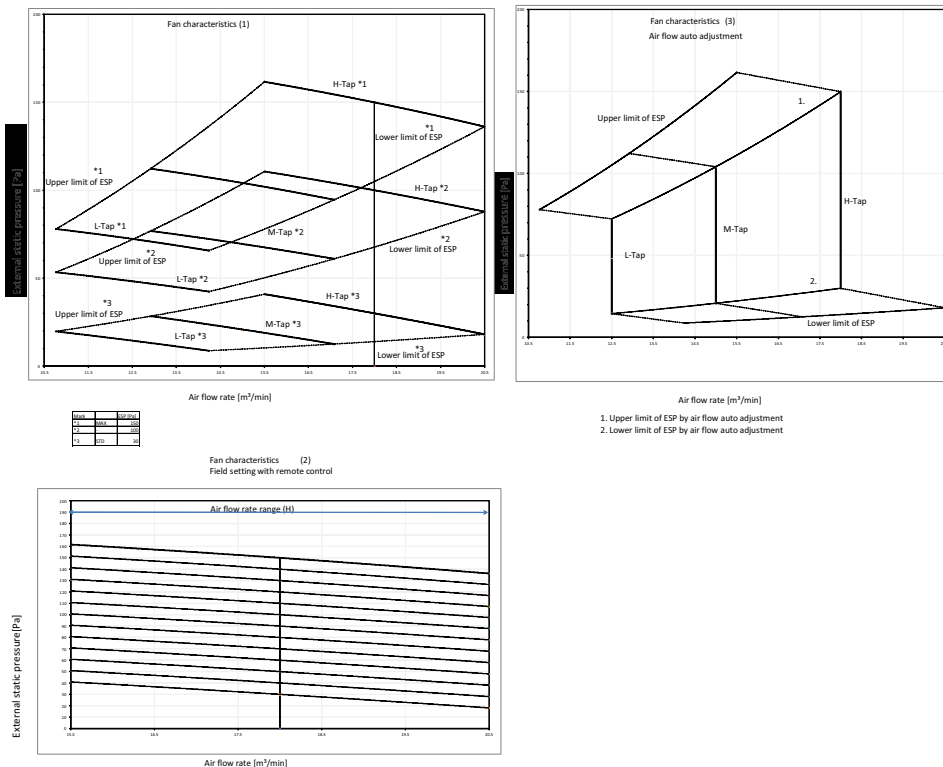

Notes:
1. Fan characteristics as shown are in "fan only" mode.
2. ESP: External static pressure.

3D095524B

9 Fan characteristics

9 - 1 Fan Characteristics

FBA100A

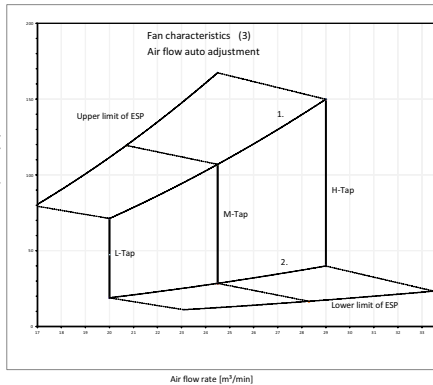
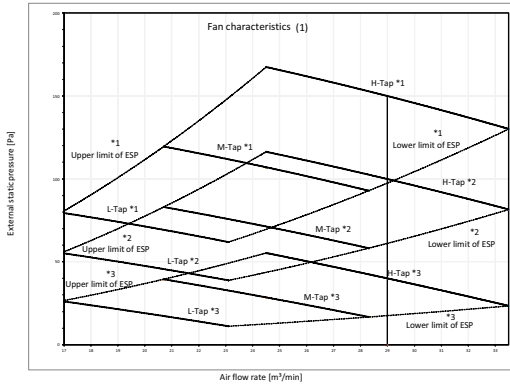

Tap	ESP (Pa)	Q (m³/min)
1	100	100
2	100	100
3	100	100

Fan characteristics (2)
Field setting with remote control

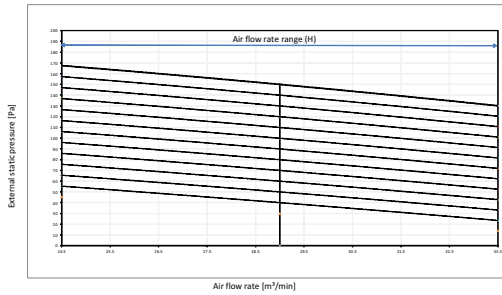

1. Upper limit of ESP by air flow auto adjustment
2. Lower limit of ESP by air flow auto adjustment

Notes:

1. Fan characteristics as shown are in "fan only" mode.
2. ESP: External static pressure.

3D095526B

FBA125-140A

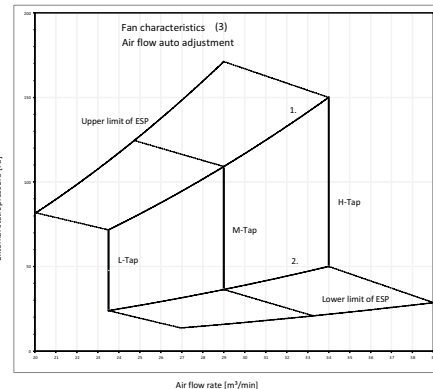
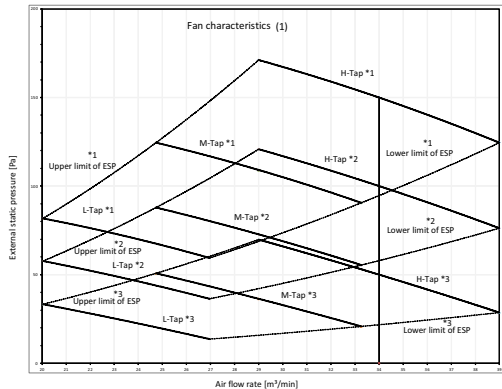

Tap	ESP (Pa)	Q (m³/min)
1	100	100
2	100	100
3	100	100

Fan characteristics (2)
Field setting with remote control

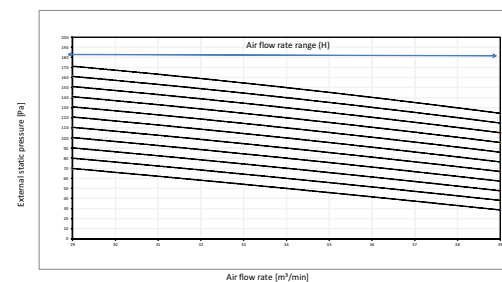

1. Upper limit of ESP by air flow auto adjustment
2. Lower limit of ESP by air flow auto adjustment

Notes:

1. Fan characteristics as shown are in "fan only" mode.
2. ESP: External static pressure.

3D095527B

10 Installation

10 - 1 Installation Method

10

FBA-A

Installation methods

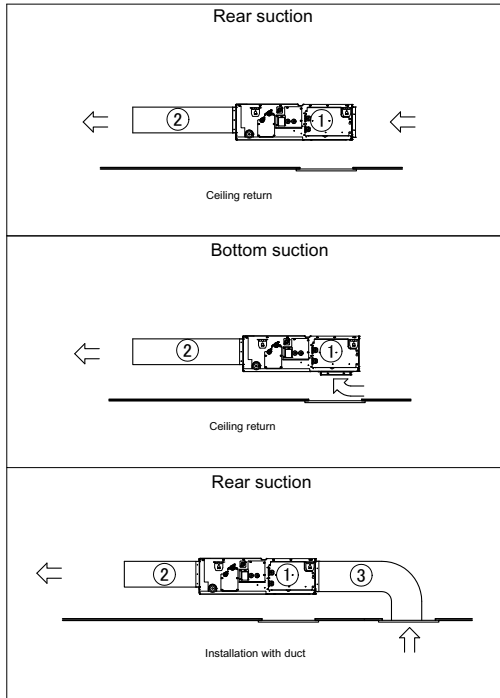

Number	Description	
①	Indoor unit	
②	Air outlet duct	Field supply
③	Air inlet duct	Field supply

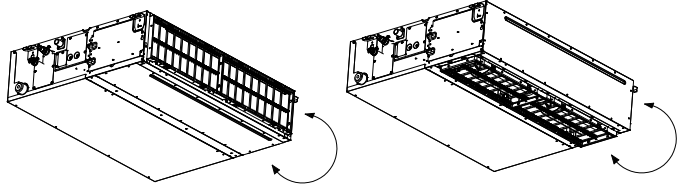

Easy modification from rear suction to bottom suction

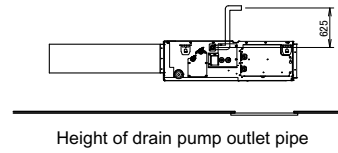

Height of drain pump outlet pipe

3D094912A



Daikin Europe N.V. Naamloze Vennootschap - Zandvoordestraat 300, B-8400 Oostende - Belgium - www.daikin.eu - BE 0412 120 336 - RPR Oostende

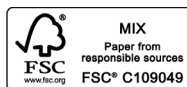
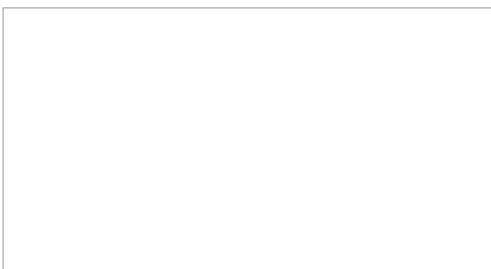

EEDEN17 05/17



Daikin Europe N.V. participates in the Eurovent Certification programme for Liquid Chilling Packages (LCP), Air handling units (AHU), Fan coil units (FCU) and variable refrigerant flow systems (VRF) Check ongoing validity of certificate online: www.eurovent-certification.com or using: www.certiflash.com



The present leaflet is drawn up by way of information only and does not constitute an offer binding upon Daikin Europe N.V.. Daikin Europe N.V. has compiled the content of this leaflet to the best of its knowledge. No express or implied warranty is given for the completeness, accuracy, reliability or fitness for particular purpose of its content and the products and services presented therein. Specifications are subject to change without prior notice. Daikin Europe N.V. explicitly rejects any liability for any direct or indirect damage, in the broadest sense, arising from or related to the use and/or interpretation of this leaflet. All content is copyrighted by Daikin Europe N.V.