

DAIKIN

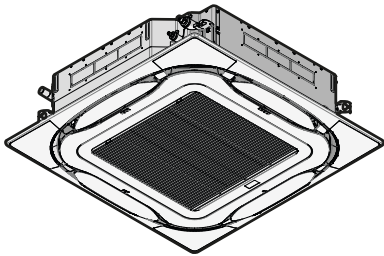

Installation and operation manual

Split system air conditioners



FCAG35BVEB
FCAG50BVEB
FCAG60BVEB
FCAG71BVEB
FCAG100BVEB
FCAG125BVEB
FCAG140BVEB

Installation and operation manual
Split system air conditioners

English

Table of Contents

1 About the documentation	3	12.4.1 About the air flow flap	14
1.1 About this document.....	3	12.5 Active circulation airflow	15
		12.5.1 To start the active circulation airflow	15
For the installer	4	13 Maintenance and service	15
2 About the box	4	13.1 Precautions for maintenance and service	15
2.1 Indoor unit	4	13.2 Cleaning the air filter, suction grille, air outlet and outside panels	15
2.1.1 To remove the accessories from the indoor unit.....	4	13.2.1 To clean the air filter	15
3 Preparation	4	13.2.2 To clean the suction grille	16
3.1 Preparing the installation site	4	13.2.3 To clean the air outlet and outside panels	16
3.1.1 Installation site requirements of the indoor unit	4	13.3 Maintenance after a long stop period	17
4 Installation	5	13.4 Maintenance before a long stop period	17
4.1 Mounting the indoor unit.....	5	13.5 About the refrigerant.....	17
4.1.1 Guidelines when installing the indoor unit.....	5	14 Troubleshooting	17
4.1.2 Guidelines when installing the drain piping.....	6	15 Disposal	18
4.2 Connecting the refrigerant piping	7	1 About the documentation	
4.2.1 To connect the refrigerant piping to the indoor unit ...	7	1.1 About this document	
4.3 Connecting the electrical wiring.....	7	Target audience	
4.3.1 Specifications of standard wiring components.....	8	Authorised installers + end users	
4.3.2 To connect the electrical wiring on the indoor unit.....	8	INFORMATION	
5 Configuration	8	This appliance is intended to be used by expert or trained users in shops, in light industry, and on farms, or for commercial and household use by lay persons.	
5.1 Field settings	8	Documentation set	
6 Commissioning	10	This document is part of a documentation set. The complete set consists of:	
6.1 Checklist before commissioning	10	▪ General safety precautions:	
6.2 To perform a test run	10	▪ Safety instructions that you must read before installing	
6.3 Error codes when performing a test run	11	▪ Format: Paper (in the box of the indoor unit)	
7 Disposal	11	▪ Indoor unit installation and operation manual:	
8 Technical data	11	▪ Installation and operation instructions	
8.1 Piping diagram: Indoor unit	11	▪ Format: Paper (in the box of the indoor unit)	
8.2 Wiring diagram	11	▪ Installer and user reference guide:	
8.2.1 Unified wiring diagram legend.....	11	▪ Preparation of the installation, good practices, reference data,...	
For the user	12	▪ Detailed step-by-step instructions and background information for basic and advanced usage	
9 About the system	12	▪ Format: Digital files on http://www.daikineurope.com/support-and-manuals/product-information/	
10 User interface	13	Latest revisions of the supplied documentation may be available on the regional Daikin website or via your dealer.	
11 Before operation	13	The original documentation is written in English. All other languages are translations.	
12 Operation	13	Technical engineering data	
12.1 Operation range	13	▪ A subset of the latest technical data is available on the regional Daikin website (publicly accessible).	
12.2 Operating the system	14	▪ The full set of latest technical data is available on the Daikin extranet (authentication required).	
12.2.1 About operating the system	14		
12.2.2 About cooling, heating, fan only, and automatic operation	14		
12.2.3 About the heating operation.....	14		
12.2.4 To operate the system	14		
12.3 Using the dry program.....	14		
12.3.1 About the dry program	14		
12.3.2 To use the dry program.....	14		
12.4 Adjusting the air flow direction.....	14		

2 About the box

For the installer

2 About the box

2.1 Indoor unit



WARNING: FLAMMABLE MATERIAL

The R32 refrigerant (if applicable) in this unit is mildly flammable. Refer to the outdoor unit specifications for the type of refrigerant to be used.

2.1.1 To remove the accessories from the indoor unit

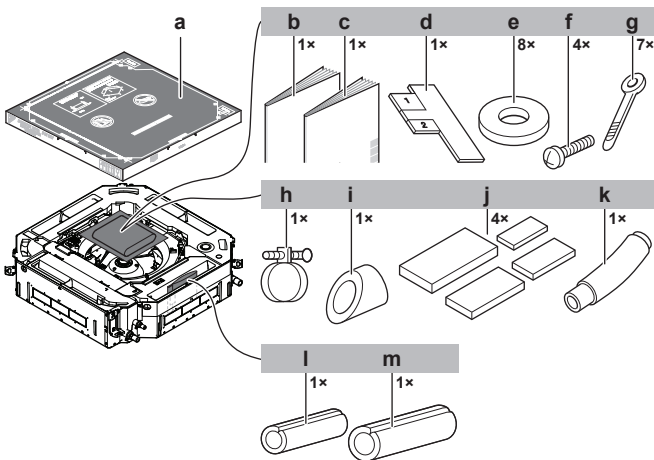

- a Paper pattern for installation (upper part of packing)
- b General safety precautions
- c Indoor unit installation and operation manual
- d Installation guide
- e Washers for hanger brackets
- f Screws (to temporarily attach the paper pattern for installation to the indoor unit)
- g Cable ties
- h Metal clamp
- i Insulation piece (drain pipe)
- j Sealing pads: Large (drain pipe), medium 1 (gas pipe), medium 2 (liquid pipe), small (electrical wiring)
- k Drain hose
- l Insulation piece: Small (liquid pipe)
- m Insulation piece: Large (gas pipe)

3 Preparation

3.1 Preparing the installation site



WARNING

The appliance shall be stored in a room without continuously operating ignition sources (example: open flames, an operating gas appliance or an operating electric heater).

3.1.1 Installation site requirements of the indoor unit



INFORMATION

The sound pressure level is less than 70 dBA.



CAUTION

Appliance not accessible to the general public, install it in a secured area, protected from easy access.

This unit, both indoor and outdoor, is suitable for installation in a commercial and light industrial environment.

- **Spacing.** Mind the following requirements:

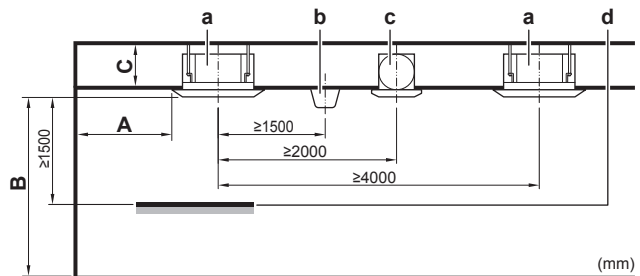

- A Minimum distance to the wall (see below)
- B Minimum and maximum distance to the floor (see below)
- C **35~71 class:**
 - ≥214 mm: In case of installation with standard panel
 - ≥256 mm: In case of installation with design panel
 - ≥294 mm: In case of installation with self-cleaning panel
 - ≥263 mm: In case of installation with fresh air intake kit
- 100~140 class:**
 - ≥256mm: In case of installation with standard panel
 - ≥298mm: In case of installation with design panel
 - ≥306mm: In case of installation with fresh air intake kit
 - ≥316mm: In case of installation with self-cleaning panel
- a Indoor unit
- b Lighting (the figure shows ceiling-mounted lighting, but recessed lighting is also allowed)
- c Air fan
- d Static volume (example: table)

- **A: Minimum distance to the wall.** Depends on the air flow directions towards the wall.

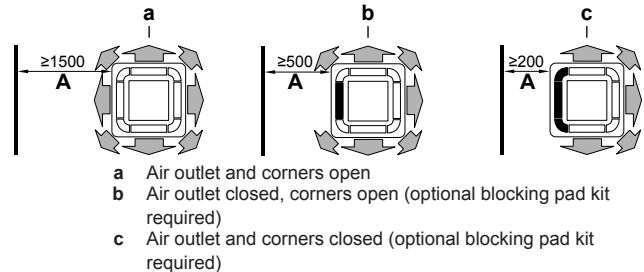

- a Air outlet and corners open
- b Air outlet closed, corners open (optional blocking pad kit required)
- c Air outlet and corners closed (optional blocking pad kit required)

- **B: Minimum and maximum distance to the floor:**

- Minimum: 2.7 m to avoid accidental touching.
- Maximum: Depends on the air flow directions and the capacity class. Also make sure the "Ceiling height" field setting corresponds with the actual situation. See ["5.1 Field settings" on page 8](#).

If air flow direction...	Then B	
	FCAG35~71	FCAG100~140
All-round	≤3.5 m	≤4.2 m
4-way ^(a)	≤4.0 m	≤4.5 m
3-way ^(a)	≤3.5 m	≤4.2 m

(a) Optional blocking kit required

4 Installation

4.1 Mounting the indoor unit

4.1.1 Guidelines when installing the indoor unit

i INFORMATION

Optional equipment. When installing optional equipment, also read the installation manual of the optional equipment. Depending on the field conditions, it might be easier to install the optional equipment first.

- **In case of installation with a fresh air intake kit.** Install the fresh air intake kit always **before** installing the unit.
- **Decoration panel.** Install the decoration panel always **after** installing the unit.
- **Ceiling strength.** Check whether the ceiling is strong enough to support the weight of the unit. If there is a risk, reinforce the ceiling before installing the unit.
 - For existing ceilings, use anchors.
 - For new ceilings, use sunken inserts, sunken anchors or other field supplied parts.

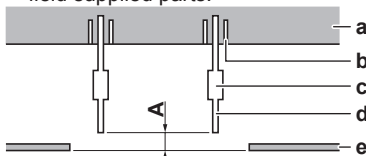

- A** 50~100 mm: In case of installation with standard panel
 100~150 mm: In case of installation with fresh air intake kit or design panel
 130~180 mm: In case of installation with self-cleaning decoration panel

- a** Ceiling slab
b Anchor
c Long nut or turnbuckle
d Suspension bolt
e Suspended ceiling

- **Suspension bolts.** Use M8~M10 suspension bolts for installation. Attach the hanger bracket to the suspension bolt. Fix it securely using a nut and washer from the upper and lower sides of the hanger bracket.

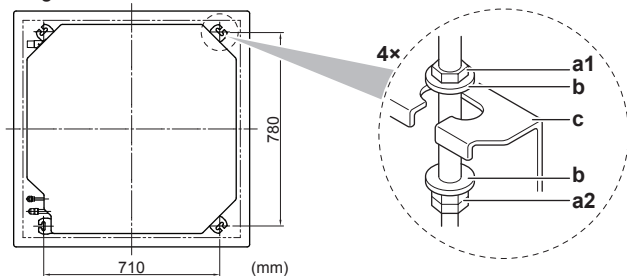

- a1** Nut (field supply)
a2 Double nut (field supply)
b Washer (accessories)
c Hanger bracket (attached to the unit)

- **Paper pattern for installation** (upper part of the packing). Use the paper pattern to determine the correct horizontal positioning. It contains the necessary dimensions and centers. You can attach the paper pattern to the unit.

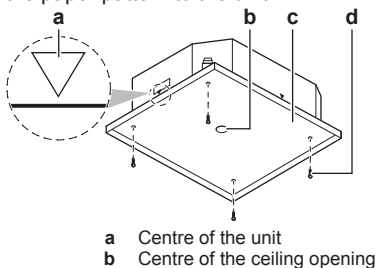

- c** Paper pattern for installation (upper part of the packing)
- d** Screws (accessories)

• **Ceiling opening and unit:**

- Make sure the ceiling opening is within the following limits:
Minimum: 860 mm to be able to fit the unit.

Maximum: 910 mm to ensure enough overlap between the decoration panel and the suspended ceiling. If the ceiling opening is larger, add extra ceiling material.

- Make sure the unit and its hanger brackets (suspension) are centered within the ceiling opening.

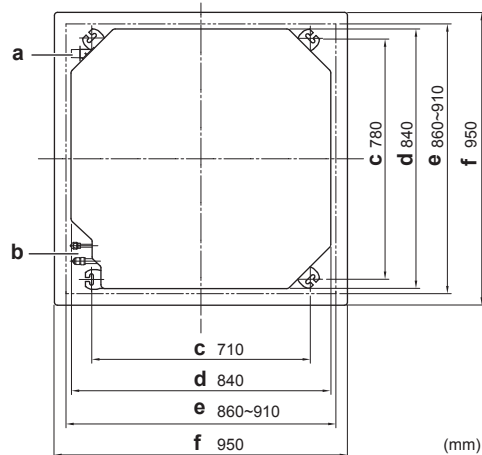

- a** Drain piping
b Refrigerant piping
c Hanger bracket pitch (suspension)
d Unit
e Ceiling opening
f Decoration panel

	If A	Then	
		B	C
	≥860 mm	10 mm	45 mm
	≤910 mm	35 mm	20 mm

- A** Ceiling opening
B Distance between the unit and the ceiling opening
C Overlap between the decoration panel and the suspended ceiling

- **Installation guide.** Use the installation guide to determine the correct vertical position.

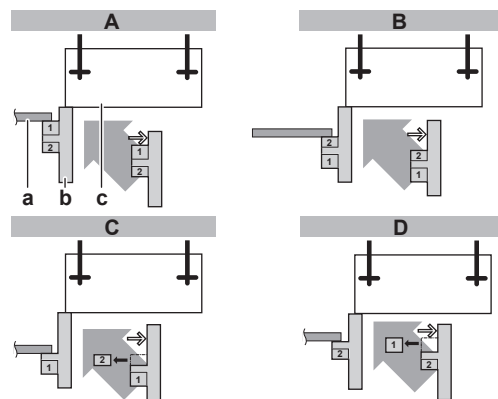

- A** In case of installation with standard decoration panel
B In case of installation with fresh air intake kit
C In case of installation with self-cleaning decoration panel
D In case of installation with design decoration panel
a Suspended ceiling
b Installation guide (accessory)
c Unit

4 Installation

- **Level.** Make sure the unit is level at all 4 corners using a level or a water-filled vinyl tube.

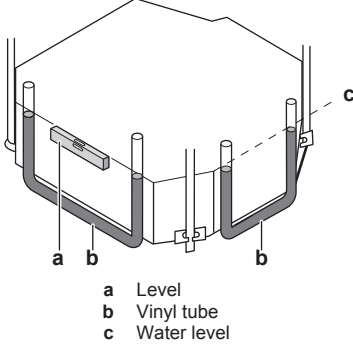

NOTICE

Do NOT install the unit tilted. **Possible consequence:** If the unit is tilted against the direction of the condensate flow (the drain piping side is raised), the float switch might malfunction and cause water to drip.

4.1.2 Guidelines when installing the drain piping

Make sure condensation water can be evacuated properly. This involves:

- General guidelines
- Connecting the drain piping to the indoor unit
- Checking for water leaks

General guidelines

- **Pipe length.** Keep drain piping as short as possible.
- **Pipe size.** Keep the pipe size equal to or greater than that of the connecting pipe (vinyl pipe of 25 mm nominal diameter and 32 mm outer diameter).
- **Slope.** Make sure the drain piping slopes down (at least 1/100) to prevent air from being trapped in the piping. Use hanging bars as shown.

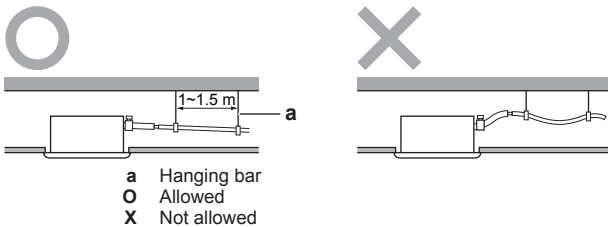

- **Rising piping.** If necessary to make the slope possible, you can install rising piping.
 - Drain hose inclination: 0~75 mm to avoid stress on the piping and to avoid air bubbles.
 - Rising piping: ≤300 mm from the unit, ≤675 mm perpendicular to the unit.

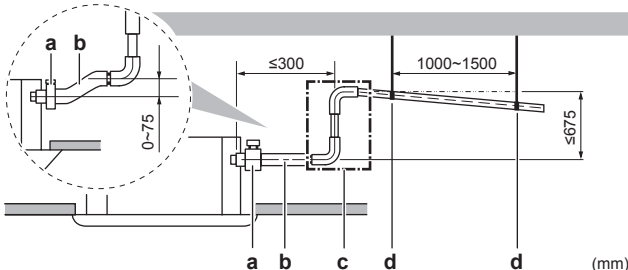

- a Metal clamp (accessory)
b Drain hose (accessory)
c Rising drain piping (vinyl pipe of 25 mm nominal diameter and 32 mm outer diameter) (field supply)

d Hanging bars (field supply)

- **Condensation.** Take measures against condensation. Insulate the complete drain piping in the building.
- **Combining drain pipes.** You can combine drain pipes. Make sure to use drain pipes and T-joints with a correct gauge for the operating capacity of the units.

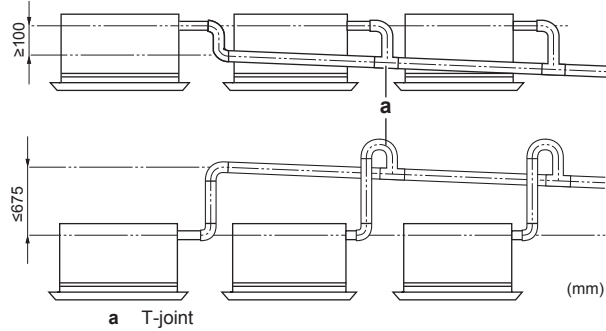

To connect the drain piping to the indoor unit



NOTICE

Incorrect connection of the drain hose might cause leaks, and damage the installation space and surroundings.

- 1 Push the drain hose as far as possible over the drain pipe connection.
- 2 Tighten the metal clamp until the screw head is less than 4 mm from the metal clamp part.
- 3 Check for water leaks (see "To check for water leaks" on page 6).
- 4 Install the insulation piece (drain pipe).
- 5 Wind the large sealing pad (= insulation) around the metal clamp and drain hose, and fix it with cable ties.
- 6 Connect the drain piping to the drain hose.

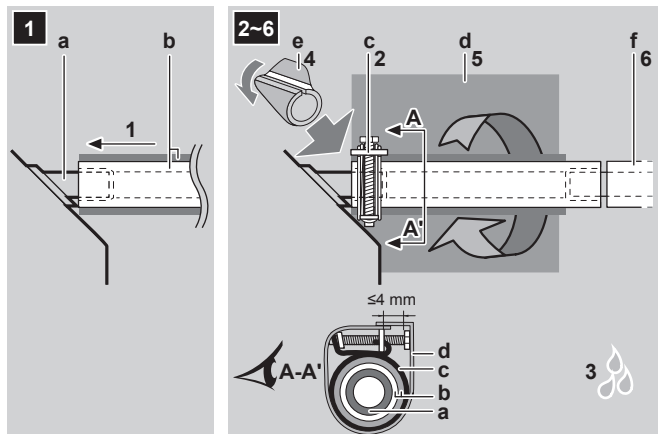

- a Drain pipe connection (attached to the unit)
b Drain hose (accessory)
c Metal clamp (accessory)
d Large sealing pad (accessory)
e Insulation piece (drain pipe) (accessory)
f Drain piping (field supply)

To check for water leaks

The procedure differs depending on whether electrical wiring is already finished. When electrical wiring is not finished yet, you need to temporarily connect the user interface and power supply to the unit.

When electrical wiring is not finished yet

- 1 Temporarily connect electrical wiring.

- Remove the switch box cover (a).
- Connect the user interface (b).
- Connect the power supply (1~ 220-240 V 50/60 Hz) and earth (c).
- Reattach the switch box cover (a).

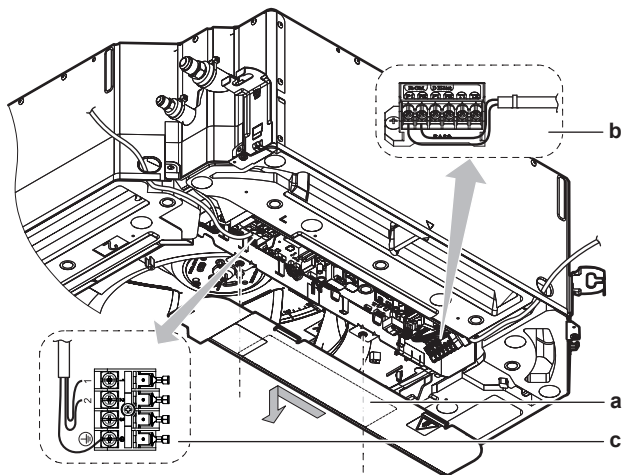

- Turn ON the power.
- Start cooling operation (see "6.2 To perform a test run" on page 10).
- Gradually pour approximately 1 l of water through the air discharge outlet, and check for leaks.

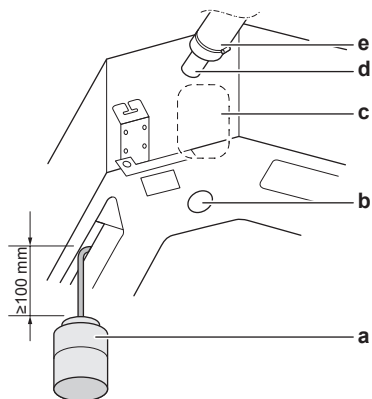

- Plastic watering can
- Service drain outlet (with rubber plug). Use this outlet to drain water from the drain pan.
- Drain pump location
- Drain pipe connection
- Drain pipe

- Turn OFF the power.
- Disconnect the electrical wiring.
 - Remove the switch box cover.
 - Disconnect the power supply and earth.
 - Disconnect the user interface.
 - Reattach the switch box cover.

When electrical wiring is finished already

- Start cooling operation (see "6.2 To perform a test run" on page 10).
- Gradually pour approximately 1 l of water through the air discharge outlet, and check for leaks (see "When electrical wiring is not finished yet" on page 6).

4.2 Connecting the refrigerant piping



DANGER: RISK OF BURNING

4.2.1 To connect the refrigerant piping to the indoor unit



CAUTION

Install the refrigerating piping or components in a position where they are unlikely to be exposed to any substance which may corrode components containing refrigerant, unless the components are constructed of materials that are inherently resistant to corrosion or are suitably protected against corrosion.



WARNING: FLAMMABLE MATERIAL

The R32 refrigerant (if applicable) in this unit is mildly flammable. Refer to the outdoor unit specifications for the type of refrigerant to be used.

- Pipe length.** Keep refrigerant piping as short as possible.
- Flare connections.** Connect refrigerant piping to the unit using flare connections.
- Insulation.** Insulate the refrigerant piping on the indoor unit as follows:

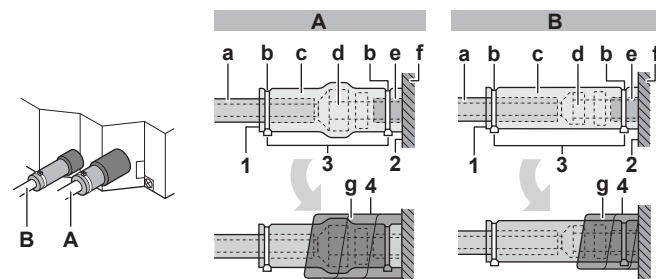

- Gas piping
- Liquid piping

- Insulation material (field supply)
- Cable tie (accessory)
- Insulation pieces: Large (gas pipe), small (liquid pipe) (accessories)
- Flare nut (attached to the unit)
- Refrigerant pipe connection (attached to the unit)
- Unit
- Sealing pads: Medium 1 (gas pipe), medium 2 (liquid pipe) (accessories)

- Turn up the seams of the insulation pieces.
- Attach to the base of the unit.
- Tighten the cable ties on the insulation pieces.
- Wrap the sealing pad from the base of the unit to the top of the flare nut.



NOTICE

Make sure to insulate all refrigerant piping. Any exposed piping might cause condensation.

4.3 Connecting the electrical wiring



DANGER: RISK OF ELECTROCUTION



WARNING

ALWAYS use multicore cable for power supply cables.



WARNING

Use an all-pole disconnection type breaker with at least 3 mm between the contact point gaps that provide full disconnection under overvoltage category III.



WARNING

If the supply cord is damaged, it MUST be replaced by the manufacturer, its service agent or similarly qualified persons in order to avoid a hazard.

5 Configuration

4.3.1 Specifications of standard wiring components

Component	Specification
Interconnection cable (indoor↔outdoor)	4-core cable 1.5 mm ² ~2.5 mm ² and applicable for 220~240 V H05RN-F (60245 IEC 57)
User interface cable	Vinyl cords with 0.75 to 1.25 mm ² sheath or cables (2-core wires) Maximum 500 m H03VV-F (60227 IEC 52)

4.3.2 To connect the electrical wiring on the indoor unit

NOTICE

- Follow the wiring diagram (delivered with the unit, located at the inside of the service cover).
- For instructions on how to connect the decoration panel and the sensor kit, see the installation manual delivered with the panel or the kit.
- Make sure the electrical wiring does NOT obstruct proper reattachment of the service cover.

It is important to keep the power supply and the transmission wiring separated from each other. In order to avoid any electrical interference the distance between both wirings should ALWAYS be at least 50 mm.

NOTICE

Be sure to keep the power line and transmission line apart from each other. Transmission wiring and power supply wiring may cross, but may NOT run parallel.

- Remove the service cover.
- User interface cable:** Route the cable through the frame, connect the cable to the terminal block, and fix the cable with a cable tie.
- Interconnection cable (indoor↔outdoor):** Route the cable through the frame, connect the cable to the terminal block (make sure the numbers match with the numbers on the outdoor unit, and connect the earth wire), and fix the cable with a cable tie.
- Divide the small sealing (accessory) and wrap it around the cables to prevent water from entering the unit. Seal all gaps to prevent small animals from entering the system.

WARNING

Provide adequate measures to prevent that the unit can be used as a shelter by small animals. Small animals that make contact with electrical parts can cause malfunctions, smoke or fire.

- Reattach the service cover.

NOTICE

When closing the service cover, make sure that the tightening torque for screws is $\leq 1.5\text{N}\cdot\text{m}$.

- Following installation is for pair type or multi-system. For more installation options, see the Installer reference guide of the indoor unit.

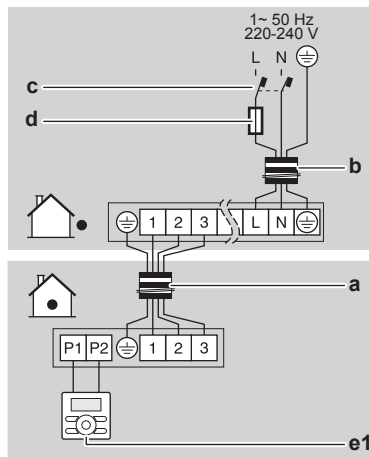

- a Interconnection cable
- b Power supply cable
- c Earth leakage circuit breaker
- d Fuse
- e1 Main user interface

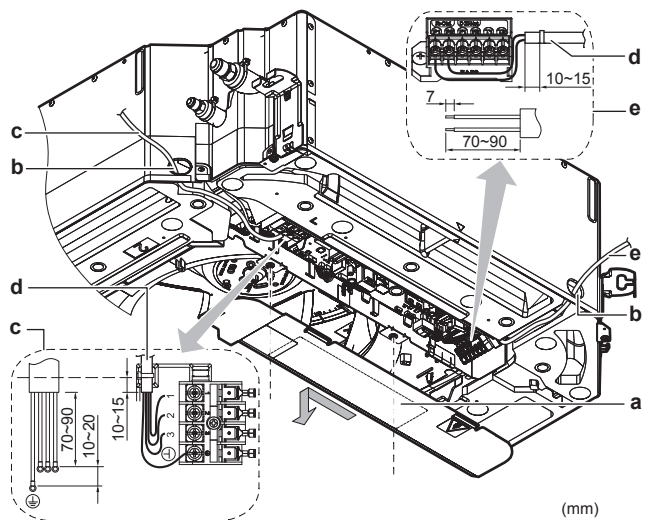

- a Service cover (with wiring diagram on the back)
- b Opening for cables
- c Connection of interconnection cable (including earth)
- d Cable tie
- e Connection of user interface cable

5 Configuration

5.1 Field settings

Make the following field settings so that they correspond with the actual installation setup and with the needs of the user:

- Ceiling height
- Design decoration panel (if applicable)
- Air flow direction
- Air volume when thermostat control is OFF
- Time to clean air filter

Setting: Ceiling height

This setting must correspond with the actual distance air to the floor, capacity class and air flow directions.

- For 3-way and 4-way air flows (which require an optional blocking pad kit), see the installation manual of the optional blocking pad kit.
- For all-round air flow, use the table below.

If the distance to the floor is (m)	Then ¹		
	M	C1	C2
≤2.7	13 (23)	0	01
2.7<x≤3.0			02
3.0<x≤3.5			03

Setting: Decoration panel type

When installing or changing the decoration panel type, ALWAYS check if the correct values are set.

If the ... decoration panel is used	Then ¹		
	M	C1	C2
Standard or self-cleaning	13 (23)	15	01
Design			02

Setting: Air flow direction

This setting must correspond with the actual used air flow directions. See the installation manual of the optional blocking pad kit and the manual of the user interface.

Default: 01 (= all-round air flow)

Example:

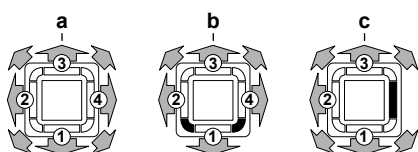

- a All-round air flow
- b 4-way air flow (all air outlets open, 2 corners closed) (optional blocking pad kit required)
- c 3-way air flow (1 air outlet closed, all corners open) (optional blocking pad kit required)

Setting: Air volume when thermostat control is OFF

This setting must correspond with the needs of the user. It determines the fan speed of the indoor unit during thermostat OFF condition.

- 1 If you have set the fan to operate, set the air volume speed:

	If you want	Then ¹		
		M	C1	C2
	Outdoor unit			
	General			
	3MXM, 4MXM, 5MXM			
During cooling operation	LL ²	12 (22)	6	01
	Setup volume ²			02
During heating operation	LL ²	12 (22)	3	01
	Setup volume ²			02

Setting: Time to clean air filter

This setting must correspond with the air contamination in the room. It determines the interval at which the **TIME TO CLEAN AIR FILTER** notification is displayed on the user interface. When using a wireless user interface, you must also set the address (see the installation manual of the user interface).

If you want an interval of... (air contamination)	Then ¹		
	M	C1	C2
±2500 h (light)	10 (20)	0	01
±1250 h (heavy)			02
No notification		3	02

Individual setting in a simultaneous operation system

We recommend using the optional user interface to set the slave unit.

Perform the following steps:

- 2 Change the second code number to 02 to perform individual setting on the slave unit.

If you want to set the slave unit as...	Then ¹		
	M	C1	C2
Unified setting	21(11)	01	01
Individual setting			02

- 3 Perform field setting for the master unit.
- 4 Turn off the main power supply switch.
- 5 Disconnect the remote controller from the master unit and connect it to the slave unit.
- 6 Change to individual setting.
- 7 Perform field setting for the slave unit.
- 8 Turn off the main power supply or, in case of more slave units, repeat the previous steps for all slave units.
- 9 Disconnect the user interface from the slave unit and reconnect it to the master unit.

It is not necessary to rewire the remote controller from the master unit if the optional user interface is used. (However, remove the wires attached to the user interface terminal board of the master unit)

⁽¹⁾ Field settings are defined as follows:

- **M**: Mode number – **First number**: for group of units – **Number between brackets**: for individual unit
- **C1**: First code number
- **C2**: Second code number
- **■**: Default

⁽²⁾ Fan speed:

- **LL**: Low fan speed
- **Setup volume**: The fan speed corresponds to the speed the user has set (low, medium, high) using the fan speed button on the user interface.
- **Monitoring 1, 2**: The fan is OFF, but runs for a short time every 6 minutes to detect the room temperature by Low fan speed (1) or by Setup volume (2).

6 Commissioning

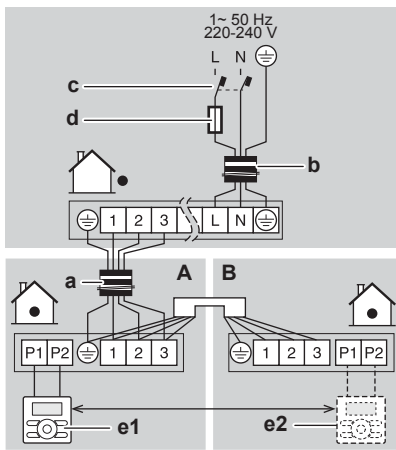

- A Master unit
- B Slave unit
- a Interconnection cable
- b Power supply cable
- c Earth leakage circuit breaker
- d Fuse
- e1 Main user interface
- e2 Optional user interface

6 Commissioning



NOTICE

NEVER operate the unit without thermistors and/or pressure sensors/switches. Burning of the compressor might result.

6.1 Checklist before commissioning

After the installation of the unit, first check the following items. Once all below checks are fulfilled, the unit MUST be closed, ONLY then can the unit be powered up.

<input type="checkbox"/>	You read the complete installation instructions, as described in the installer reference guide .
<input type="checkbox"/>	The indoor units are properly mounted.
<input type="checkbox"/>	In case a wireless user interface is used: The indoor unit decoration panel with infrared receiver is installed.
<input type="checkbox"/>	The outdoor unit is properly mounted.
<input type="checkbox"/>	There are NO missing phases or reversed phases .
<input type="checkbox"/>	The system is properly earthed and the earth terminals are tightened.
<input type="checkbox"/>	The fuses or locally installed protection devices are installed according to this document, and have NOT been bypassed.
<input type="checkbox"/>	The power supply voltage matches the voltage on the identification label of the unit.
<input type="checkbox"/>	There are NO loose connections or damaged electrical components in the switch box.
<input type="checkbox"/>	The insulation resistance of the compressor is OK.
<input type="checkbox"/>	There are NO damaged components or squeezed pipes on the inside of the indoor and outdoor units.
<input type="checkbox"/>	There are NO refrigerant leaks .
<input type="checkbox"/>	The correct pipe size is installed and the pipes are properly insulated.
<input type="checkbox"/>	The stop valves (gas and liquid) on the outdoor unit are fully open.

6.2 To perform a test run

This task is only applicable when using the BRC1E52 or BRC1E53 user interface. When using any other user interface, see the installation manual or service manual of the user interface.



NOTICE

Do not interrupt the test run.



INFORMATION

Backlight. To perform an ON/OFF action on the user interface, the backlight does not need to be lit. For any other action, it needs to be lit first. The backlight is lit for ± 30 seconds when you press a button.

1 Perform introductory steps.

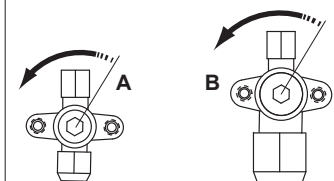

#	Action
1	Open the liquid stop valve (A) and gas stop valve (B) by removing the stem cap and turning counterclockwise with a hex wrench until it stops. 
2	Close the service cover to prevent electric shocks.
3	Turn ON power for at least 6 hours before starting operation to protect the compressor.
4	On the user interface, set the unit to cooling operation mode.

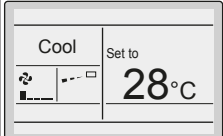
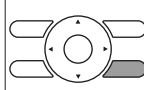
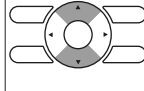
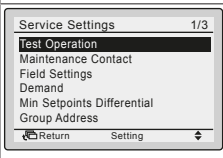
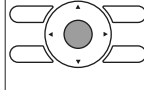
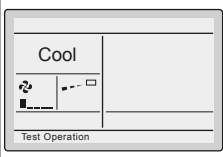
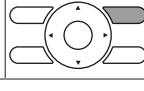
2 Start the test run

#	Action	Result
1	Go to the home menu.	
2	Press at least 4 seconds. 	The Service Settings menu is displayed.
3	Select Test Operation. 	
4	Press. 	Test Operation is displayed on the home menu. 
5	Press within 10 seconds. 	Test run starts.

3 Check operation for 3 minutes.

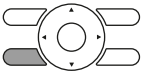
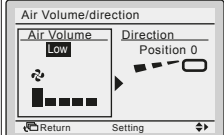
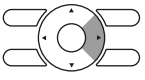
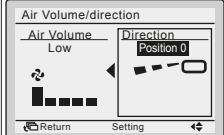
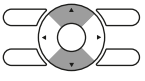
4 Check operation of the airflow direction.

#	Action	Result
1	Press. 	
2	Select Position 0. 	
3	Change the position. 	If the airflow flap of the indoor unit moves, operation is OK. If not, operation is not OK.
4	Press. 	The home menu is displayed.

5 Stop the test run.

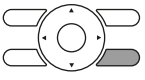
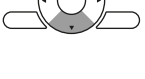
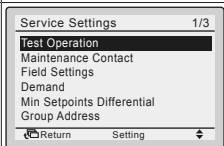
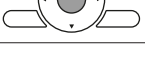
#	Action	Result
1	Press at least 4 seconds. 	The Service Settings menu is displayed.
2	Select Test Operation. 	
3	Press. 	The unit returns to normal operation, and the home menu is displayed.

6.3 Error codes when performing a test run

If the installation of the outdoor unit has NOT been done correctly, the following error codes may be displayed on the user interface:

Error code	Possible cause
Nothing displayed (the currently set temperature is not displayed)	<ul style="list-style-type: none"> The wiring is disconnected or there is a wiring error (between power supply and outdoor unit, between outdoor unit and indoor units, between indoor unit and user interface). The fuse on the outdoor or indoor unit PCB has blown.

8.2 Wiring diagram

8.2.1 Unified wiring diagram legend

For applied parts and numbering, refer to the wiring diagram on the unit. Part numbering is by Arabic numbers in ascending order for each part and is represented in the overview below symbol "*" in the part code.

Symbols:

 Circuit breaker  Protective earth

Error code	Possible cause
E3, E4 or L8	<ul style="list-style-type: none"> The stop valves are closed. The air inlet or air outlet is blocked.
E7	There is a missing phase in case of three-phase power supply units. Note: Operation will be impossible. Turn OFF the power, recheck the wiring, and switch two of the three electrical wires.
L4	The air inlet or air outlet is blocked.
U0	The stop valves are closed.
U2	<ul style="list-style-type: none"> There is a voltage imbalance. There is a missing phase in case of three-phase power supply units. Note: Operation will be impossible. Turn OFF the power, recheck the wiring, and switch two of the three electrical wires.
U4 or UF	The inter-unit branch wiring is not correct.
UA	The outdoor and indoor unit are incompatible.

7 Disposal



NOTICE

Do NOT try to dismantle the system yourself: dismantling of the system, treatment of the refrigerant, oil and other parts MUST comply with applicable legislation. Units MUST be treated at a specialised treatment facility for reuse, recycling and recovery.







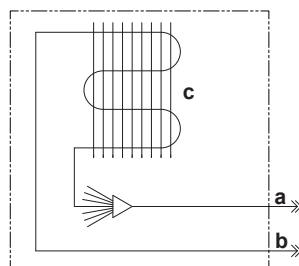



8 Technical data

- A **subset** of the latest technical data is available on the regional Daikin website (publicly accessible).
- The **full set** of latest technical data is available on the Daikin extranet (authentication required).





8.1 Piping diagram: Indoor unit



- a Liquid pipe connection
- b Gas pipe connection
- c Heat exchanger

	Connection		Protective earth (screw)
	Connector		Rectifier
	Earth		Relay connector
	Field wiring		Short-circuit connector
	Fuse		Terminal

9 About the system

	Indoor unit		Terminal strip	M*S	Swing motor
	Outdoor unit		Wire clamp	MR*, MRCW*, MRM*, MRN*	Magnetic relay
Colors:				N	Neutral
BLK	Black	ORG	Orange	n=*, N=*	Number of passes through ferrite core
BLU	Blue	PNK	Pink	PAM	Pulse-amplitude modulation
BRN	Brown	PRP, PPL	Purple	PCB*	Printed circuit board
GRN	Green	RED	Red	PM*	Power module
GRY	Grey	WHT	White	PS	Switching power supply
		YLW	Yellow	PTC*	Thermistor PTC
Legends:				Q*	Insulated gate bipolar transistor (IGBT)
A*P			Printed circuit board	Q*DI	Earth leak circuit breaker
BS*			Pushbutton ON/OFF, operation switch	Q*L	Overload protector
BZ, H*C			Buzzer	Q*M	Thermo switch
C*			Capacitor	R*	Resistor
AC*, CN*, E*, HA*, HE*, HL*, HN*, HR*, MR*_A, MR*_B, S*, U, V, W, X*A, K*R_*			Connection, connector	R*T	Thermistor
D*, V*D			Diode	RC	Receiver
DB*			Diode bridge	S*C	Limit switch
DS*			Dip switch	S*L	Float switch
E*H			Heater	S*NPH	Pressure sensor (high)
FU*, F*U, (for characteristics, refer to PCB inside your unit)			Fuse	S*NPL	Pressure sensor (low)
FG*			Connector (frame ground)	S*PH, HPS*	Pressure switch (high)
H*			Harness	S*PL	Pressure switch (low)
H*P, LED*, V*L			Pilot lamp, light emitting diode	S*T	Thermostat
HAP			Light emitting diode (service monitor green)	S*RH	Humidity sensor
HIGH VOLTAGE			High voltage	S*W, SW*	Operation switch
IES			Intelligent eye sensor	SA*, F1S	Surge arrestor
IPM*			Intelligent power module	SR*, WLU	Signal receiver
K*R, KCR, KFR, KHuR, K*M			Magnetic relay	SS*	Selector switch
L			Live	SHEET METAL	Terminal strip fixed plate
L*			Coil	T*R	Transformer
L*R			Reactor	TC, TRC	Transmitter
M*			Stepper motor	V*, R*V	Varistor
M*C			Compressor motor	V*R	Diode bridge
M*F			Fan motor	WRC	Wireless remote controller
M*P			Drain pump motor	X*	Terminal
				X*M	Terminal strip (block)
				Y*E	Electronic expansion valve coil
				Y*R, Y*S	Reversing solenoid valve coil
				Z*C	Ferrite core
				ZF, Z*F	Noise filter

For the user

9 About the system

The indoor unit of this split system air conditioner can be used for heating/cooling applications.



NOTICE

Do NOT use the system for other purposes. In order to avoid any quality deterioration, do NOT use the unit for cooling precision instruments, food, plants, animals, or works of art.

NOTICE

For future modifications or expansions of your system:

A full overview of allowable combinations (for future system extensions) is available in technical engineering data and should be consulted. Contact your installer to receive more information and professional advice.

10 User interface

CAUTION

- NEVER touch the internal parts of the controller.
- Do NOT remove the front panel. Some parts inside are dangerous to touch and appliance problems may happen. For checking and adjusting the internal parts, contact your dealer.

This operation manual will give a non-exhaustive overview of the main functions of the system.

For more information about the user interface, see the operation manual of the installed user interface.

11 Before operation

WARNING

This unit contains electrical and hot parts.

WARNING

Before operating the unit, be sure the installation has been carried out correctly by an installer.

CAUTION

It is not good for your health to expose your body to the air flow for a long time.

CAUTION

To avoid oxygen deficiency, ventilate the room sufficiently if equipment with burner is used together with the system.

CAUTION

Do NOT operate the system when using a room fumigation-type insecticide. Chemicals could collect in the unit, and endanger the health of people who are hypersensitive to chemicals.

NOTICE

Be sure to turn on the power 6 hours before operation in order to have power running to the crankcase heater and to protect the compressor.

This operation manual is for the following systems with standard control. Before initiating operation, contact your dealer for the operation that corresponds to your system type and mark. If your installation has a customised control system, ask your dealer for the operation that corresponds to your system.



















Operation modes:









- Heating and cooling (air to air).
- Fan only operation (air to air).

12 Operation





12.1 Operation range



Use the system in the following temperature and humidity ranges for safe and effective operation.

In combination with R410A outdoor units			
Outdoor units		Cooling	Heating
RR71~125		-15~46°C DB	—
		12~28°C WB	—
RQ71~125		-5~46°C DB	-10~15°C WB
		12~28°C WB	10~27°C DB
RXS35~60		-10~46°C DB	-15~18°C WB
		14~28°C WB	10~30°C DB
3MXS40~68 4MXS68~80 5MXS90		-10~46°C DB	-15~18°C WB
		14~28°C WB	10~30°C DB
RZQG71~140		-15~50°C DB	-20~15.5°C WB
		12~28°C WB	10~27°C DB
RZQSG71~140		-15~46°C DB	-15~15.5°C WB
		14~28°C WB	10~27°C DB
RZQ200~250		-5~46°C DB	-15~15°C WB
		14~28°C WB	10~27°C DB
AZQS71		-15~46°C DB	-15~15.5°C WB
		14~28°C WB	10~27°C DB
AZQS100~140		-5~46°C DB	-15~15.5°C WB
		14~28°C WB	10~27°C DB
Indoor humidity		≤80% ^(a)	Indoor humidity

In combination with R32 outdoor units			
Outdoor units		Cooling	Heating
RXM35~60		-10~46°C DB	-15~24°C DB -15~18°C WB
		14~28°C DB	10~30°C DB
3MXM40~68 4MXM68~80 5MXM90		-10~46°C DB	-15~24°C DB -15~18°C WB
		18~37°C DB 14~28°C WB	10~30°C DB
RZAG35~60		-20~52°C DB	-20~24°C DB -21~18°C WB
		17~38°C DB 12~28°C WB	10~27°C DB
RZAG71~140		-20~52°C DB	-20~24°C DB -20~18°C WB
		17~38°C DB 12~28°C WB	10~27°C DB

12 Operation

In combination with R32 outdoor units			
Outdoor units		Cooling	Heating
RZASG71~140		-15~46°C DB	-15~21°C DB -15~15.5°C WB
		20~38°C DB 14~28°C WB	10~27°C DB
AZAS71~140		-5~46°C DB	-15~21°C DB -15~15.5°C WB
		20~38°C DB 14~28°C WB	10~27°C DB
Indoor humidity		≤80% ^(a)	

Symbol	Explanation
	Outdoor temperature
	Indoor temperature

- (a) To avoid condensation and water dripping out of the unit. If the temperature or the humidity is beyond these conditions, safety devices may be put in action and the air conditioner may not operate.

12.2 Operating the system

12.2.1 About operating the system

- To protect the unit, turn on the main power switch 6 hours before operation.
- If the main power supply is turned off during operation, operation will restart automatically after the power turns back on again.

12.2.2 About cooling, heating, fan only, and automatic operation

- The air flow rate may adjust itself depending on the room temperature or the fan may stop immediately. This is not a malfunction.

12.2.3 About the heating operation

It may take longer to reach the set temperature for general heating operation than for cooling operation.

The following operation is performed in order to prevent the heating capacity from dropping or cold air from blowing.

Defrost operation

In heating operation, freezing of the outdoor unit's air cooled coil increases over time, restricting the energy transfer to the outdoor unit's coil. Heating capability decreases and the system needs to go into defrost operation to be able to remove frost from the outdoor unit's coil. During defrost operation the heating capacity on the indoor unit side will temporarily drop until defrosting is completed. After defrosting, the unit will regain its full heating capacity.

The indoor unit will stop fan operation, the refrigerant cycle will reverse and energy from inside the building will be used to defrost the outdoor unit coil.



The indoor unit will indicate defrost operation on the display .

Hot start

In order to prevent cold air from blowing out of an indoor unit at the start of heating operation, the indoor fan is automatically stopped. The display of the user interface shows . It may take some time before the fan starts. This is not a malfunction.

12.2.4 To operate the system

- Press the operation mode selector button on the user interface several times and select the operation mode of your choice.

-  Cooling operation
-  Heating operation
-  Fan only operation

- Press the ON/OFF button on the user interface.

Result: The operation lamp lights up and the system starts operating.

12.3 Using the dry program

12.3.1 About the dry program

- The function of this program is to decrease the humidity in your room with minimal temperature decrease (minimal room cooling).
- The micro computer automatically determines temperature and fan speed (cannot be set by the user interface).
- The system does not go into operation if the room temperature is low (<20°C).

12.3.2 To use the dry program

To start

- Press the operation mode selector button on the user interface several times and select  (program dry operation).

- Press the ON/OFF button of the user interface.

Result: The operation lamp lights up and the system starts operating.

To stop

- Press the ON/OFF button on the user interface once again.

Result: The operation lamp goes out and the system stops operating.



NOTICE

Do not turn off power immediately after the unit stops, but wait for at least 5 minutes.

12.4 Adjusting the air flow direction

Refer to the operation manual of the user interface.

12.4.1 About the air flow flap





Double flow+multi-flow units

For the following conditions, a micro computer controls the air flow direction which may be different from the display.

Cooling	Heating
<ul style="list-style-type: none"> When the room temperature is lower than the set temperature. 	<ul style="list-style-type: none"> When starting operation. When the room temperature is higher than the set temperature. At defrost operation.
<ul style="list-style-type: none"> When operating continuously at horizontal air flow direction. 	
<ul style="list-style-type: none"> When continuous operation with downward air flow is performed at the time of cooling with a ceiling-suspended or a wall-mounted unit, the micro computer may control the flow direction, and then the user interface indication will also change. 	

The air flow direction can be adjusted in one of the following ways:

- The air flow flap itself adjusts its position.
- The air flow direction can be fixed by the user.
- Automatic  and desired position .



WARNING

Never touch the air outlet or the horizontal blades while the swing flap is in operation. Fingers may become caught or the unit may break down.



NOTICE

- The movable limit of the flap is changeable. Contact your dealer for details. (only for double-flow, multi-flow, corner, ceiling-suspended and wall-mounted).
- Avoid operating in the horizontal direction . It may cause dew or dust to settle on the ceiling or flap.

12.5 Active circulation airflow

Use active circulation airflow to heat or cool the room more quickly.

12.5.1 To start the active circulation airflow

1 Set the active circulation airflow

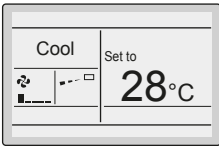
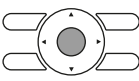
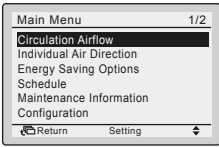
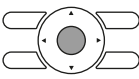
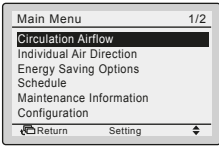
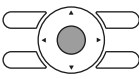
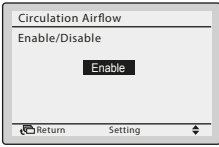
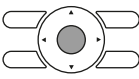
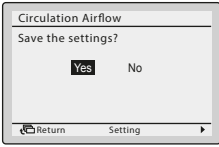
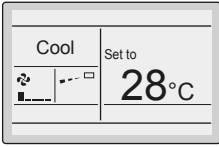
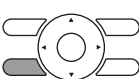
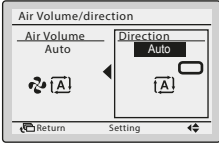
1	Go to the home screen.	
2	Press. 	
3	Select Circulation airflow 	
4	Choose enable and confirm. 	
5	Confirm setting. 	
6	Go to the home screen.	
7	Check if Air Volume/direction is set to automatic. If not set to automatic. 	

2 Turn on the unit by the user interface.

13 Maintenance and service

13.1 Precautions for maintenance and service



CAUTION

Do NOT insert fingers, rods or other objects into the air inlet or outlet. When the fan is rotating at high speed, it will cause injury.



NOTICE

Never inspect or service the unit by yourself. Ask a qualified service person to perform this work. However, as end user, you may clean the air filter, suction grille, air outlet and outside panels.



WARNING

Never replace a fuse with a fuse of a wrong ampere ratings or other wires when a fuse blows out. Use of wire or copper wire may cause the unit to break down or cause a fire.



CAUTION

After a long use, check the unit stand and fitting for damage. If damaged, the unit may fall and result in injury.



NOTICE

Do NOT wipe the controller operation panel with benzine, thinner, chemical dust cloth, etc. The panel may get discoloured or the coating peeled off. If it is heavily dirty, soak a cloth in water-diluted neutral detergent, squeeze it well and wipe the panel clean. Wipe it with another dry cloth.



CAUTION

Before accessing terminal devices, make sure to interrupt all power supply.



NOTICE

When cleaning the heat exchanger, make sure to remove the switch box, fan motor, drain pump and float switch. Water or detergent might deteriorate the insulation of electronic components and result in burnout of these components.

13.2 Cleaning the air filter, suction grille, air outlet and outside panels



CAUTION

Turn off the unit before cleaning the air filter, suction grille, air outlet and outside panels.

13.2.1 To clean the air filter

When to clean the air filter:

- Rule of thumb: Clean every 6 months. If the air in the room is extremely contaminated, increase the cleaning frequency.
- Depending on the settings, the user interface can display the **TIME TO CLEAN AIR FILTER** notification. Clean the air filter when the notification is displayed.
- If the dirt becomes impossible to clean, change the air filter (= optional equipment).

How to clean the air filter:

13 Maintenance and service

NOTICE

Do NOT use water of 50°C or higher. **Possible consequence:** Discoloration and deformation.

- 1 Open the suction grille.

Standard panel:

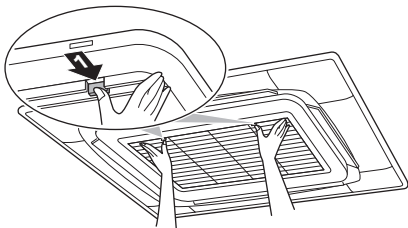

Design panel:

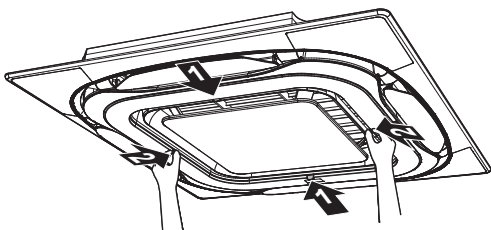

- 2 Remove the air filter.

Standard panel:

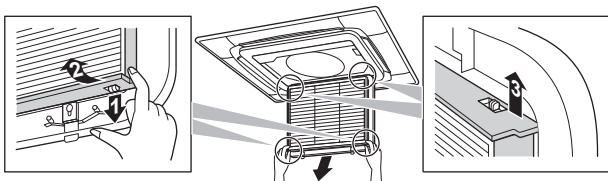

Design panel:

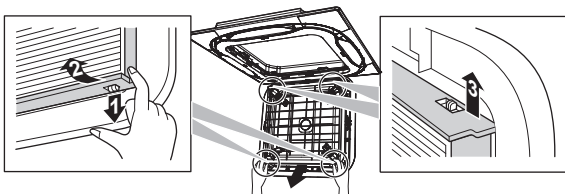

- 3 Clean the air filter. Use a vacuum cleaner or wash with water. If the air filter is very dirty, use a soft brush and neutral detergent.

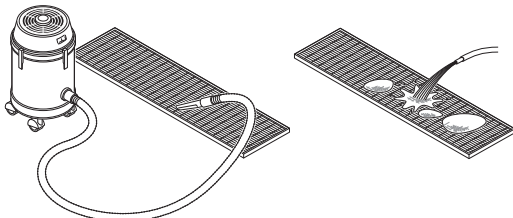

- 4 Dry the air filter in the shadow.
- 5 Reattach the air filter and close the suction grille.
- 6 Turn ON the power.
- 7 Press the **FILTER SIGN RESET** button.

Result: The **TIME TO CLEAN AIR FILTER** notification disappears from the user interface.

13.2.2 To clean the suction grille

NOTICE

Do NOT use water of 50°C or higher. **Possible consequence:** Discoloration and deformation.

- 1 Open the suction grille.

Standard panel:

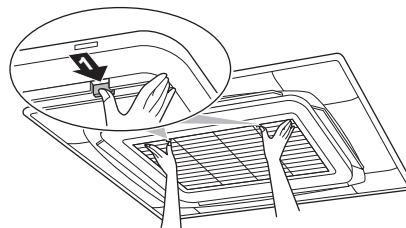

Design panel:

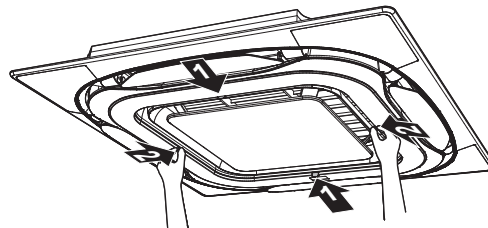

- 2 Remove the suction grille.

Standard panel:

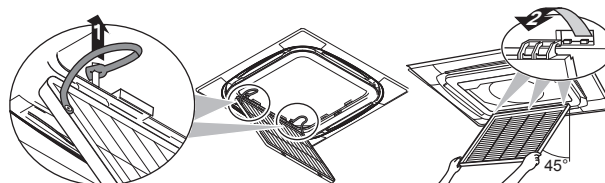

Design panel:

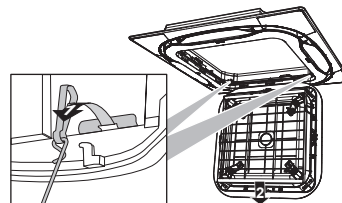

- 3 Remove the air filter.

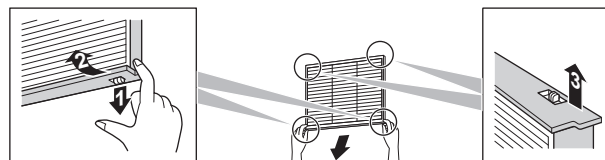

- 4 Clean the suction grille. Wash with a soft bristle brush, and water or neutral detergent. If the suction grille is very dirty, use a typical kitchen cleaner, leave it on for 10 min, then wash it with water.
- 5 Reattach the air filter and suction grille, and close the suction grille.

13.2.3 To clean the air outlet and outside panels



WARNING

Do NOT let the indoor unit get wet. **Possible consequence:** Electric shock or fire.



NOTICE

- Do NOT use gasoline, benzene, thinner polishing powder or liquid insecticide. **Possible consequence:** Discoloration and deformation.
- Do NOT use water or air of 50°C or higher. **Possible consequence:** Discoloration and deformation.
- Do NOT scrub firmly when washing the blade with water. **Possible consequence:** The surface sealing peels off.

Clean with a soft cloth. If it is difficult to remove stains, use water or neutral detergent.

13.3 Maintenance after a long stop period

E.g., at the beginning of the season.

- Check and remove everything that might be blocking inlet and outlet vents of indoor units and outdoor units.
- Clean air filters and casings of indoor units (see "13.2.1 To clean the air filter" on page 15 and "13.2.3 To clean the air outlet and outside panels" on page 16).
- Turn on the power at least 6 hours before operating the unit in order to ensure smoother operation. As soon as the power is turned on, the user interface display appears.

13.4 Maintenance before a long stop period

E.g., at the end of the season.

- Let the indoor units run in fan only operation for about half a day in order to dry the interior of the units. Refer to "12.2.2 About cooling, heating, fan only, and automatic operation" on page 14 for details on fan only operation.
- Turn off the power. The user interface display disappears.
- Clean air filters and casings of indoor units (see "13.2.1 To clean the air filter" on page 15 and "13.2.3 To clean the air outlet and outside panels" on page 16).

13.5 About the refrigerant

This product contains fluorinated greenhouse gases. Do NOT vent gases into the atmosphere.

Refrigerant type: R32

Global warming potential (GWP) value: 675

Refrigerant type: R410A

Global warming potential (GWP) value: 2087.5



NOTICE

Applicable legislation on **fluorinated greenhouse gases** requires that the refrigerant charge of the unit is indicated both in weight and CO₂ equivalent.

Formula to calculate the quantity in CO₂ equivalent tonnes: GWP value of the refrigerant × total refrigerant charge [in kg] / 1000

Please contact your installer for more information.



WARNING: FLAMMABLE MATERIAL

The R32 refrigerant (if applicable) in this unit is mildly flammable. Refer to the outdoor unit specifications for the type of refrigerant to be used.



WARNING

The appliance shall be stored in a room without continuously operating ignition sources (example: open flames, an operating gas appliance or an operating electric heater).



WARNING

- Do NOT pierce or burn refrigerant cycle parts.
- Do NOT use cleaning materials or means to accelerate the defrosting process other than those recommended by the manufacturer.
- Be aware that the refrigerant inside the system is odourless.



WARNING

R410A is a non-combustible refrigerant, and R32 is a mildly flammable refrigerant; they normally don't leak. If the refrigerant leaks in the room and comes into contact with fire from a burner, a heater, or a cooker, this may result in a fire (in case of R32), or the formation of a harmful gas.

Turn off any combustible heating devices, ventilate the room, and contact the dealer from where you purchased the unit.

Do not use the unit until a service person confirms that the part from which the refrigerant leaked has been repaired.

14 Troubleshooting

If one of the following malfunctions occur, take the measures shown below and contact your dealer.



WARNING

Stop operation and shut off the power if anything unusual occurs (burning smells etc.).

Leaving the unit running under such circumstances may cause breakage, electric shock or fire. Contact your dealer.

The system MUST be repaired by a qualified service person.

Malfunction	Measure
If a safety device such as a fuse, a breaker or an earth leakage breaker frequently actuates or the ON/OFF switch does NOT properly work.	Turn OFF the main power switch.
If water leaks from the unit.	Stop the operation.
The operation switch does NOT work well.	Turn OFF the power supply.
If the user interface display indicates the unit number, the operation lamp flashes and the malfunction code appears.	Notify your installer and report the malfunction code.

If the system does NOT properly operate except for the above mentioned cases and none of the above mentioned malfunctions is evident, investigate the system according to the following procedures.



INFORMATION

Refer to the user reference guide located on <http://www.daikineurope.com/support-and-manuals/product-information/> for more troubleshooting tips.

If after checking all above items, it is impossible to fix the problem yourself, contact your installer and state the symptoms, the complete model name of the unit (with manufacturing number if possible) and the installation date (possibly listed on the warranty card).

15 Disposal



NOTICE

Do NOT try to dismantle the system yourself: dismantling of the system, treatment of the refrigerant, oil and other parts MUST comply with applicable legislation. Units MUST be treated at a specialised treatment facility for reuse, recycling and recovery.



ERC



DAIKIN INDUSTRIES CZECH REPUBLIC s.r.o.

U Nové Hospody 1/1155, 301 00 Plzeň Skvrňany, Czech Republic

DAIKIN EUROPE N.V.

Zandvoordestraat 300, B-8400 Oostende, Belgium

Copyright 2018 Daikin

4P535626-1B 2019.01